

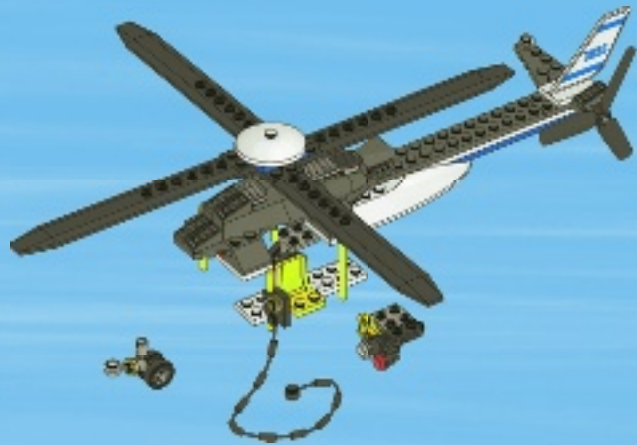

# CITY

3658







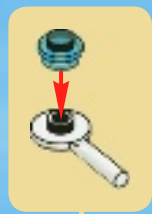
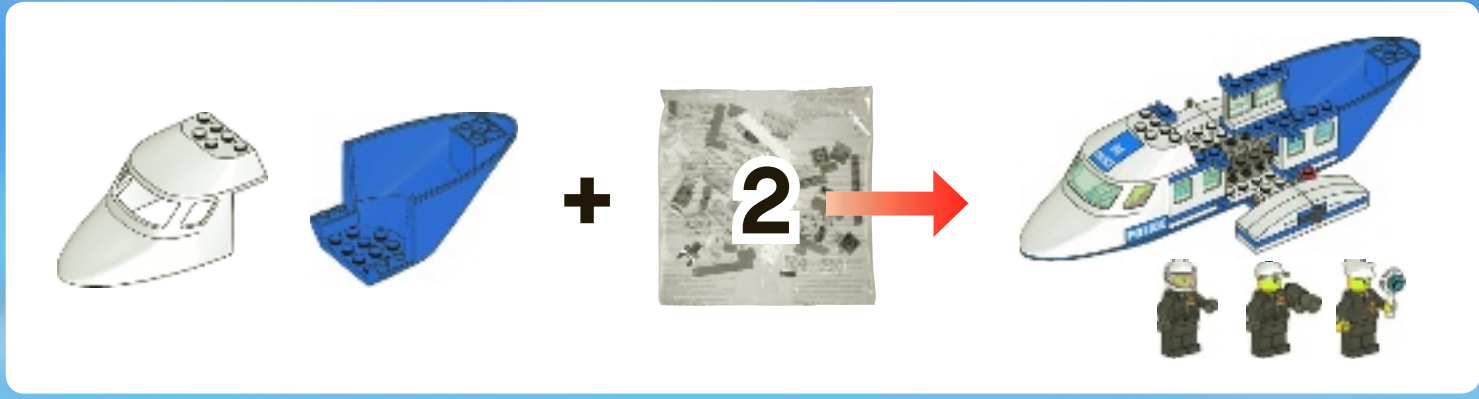

1

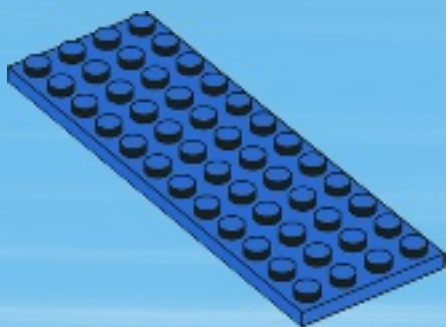

2

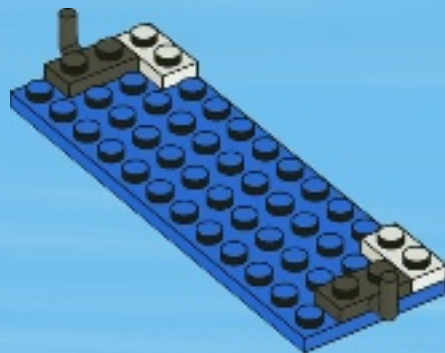

3

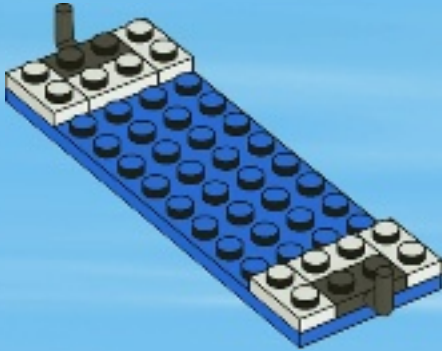

4





5



6

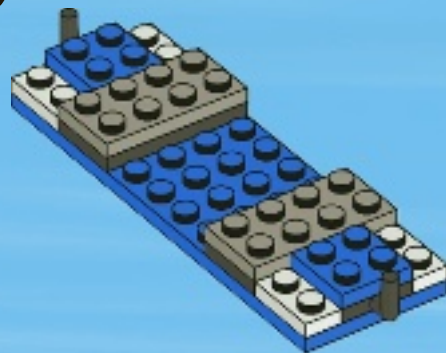

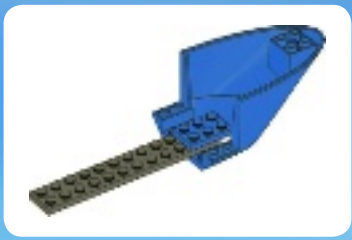

1

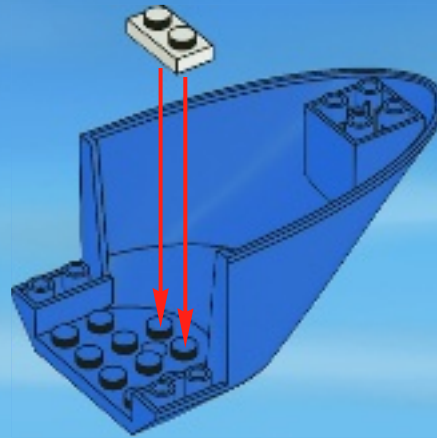

2

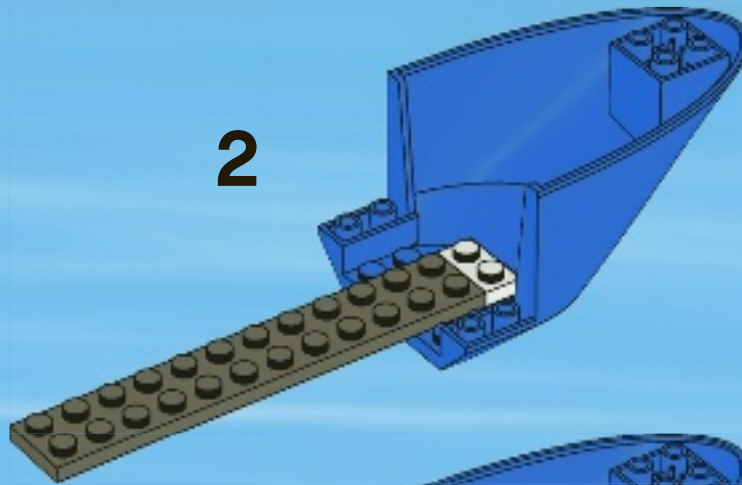

3

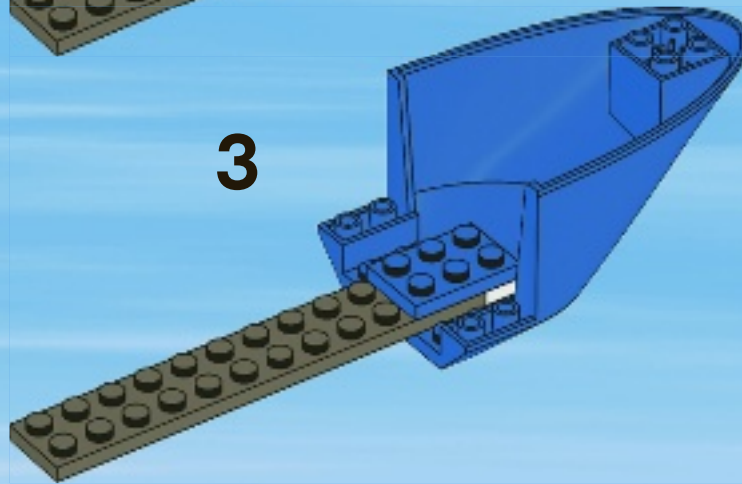

7

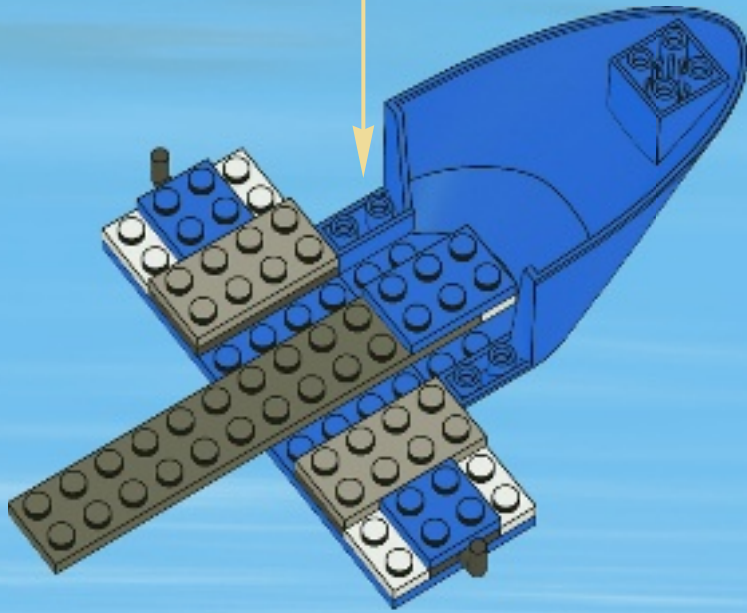



8

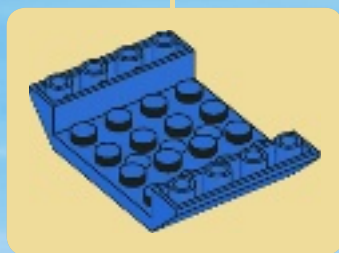
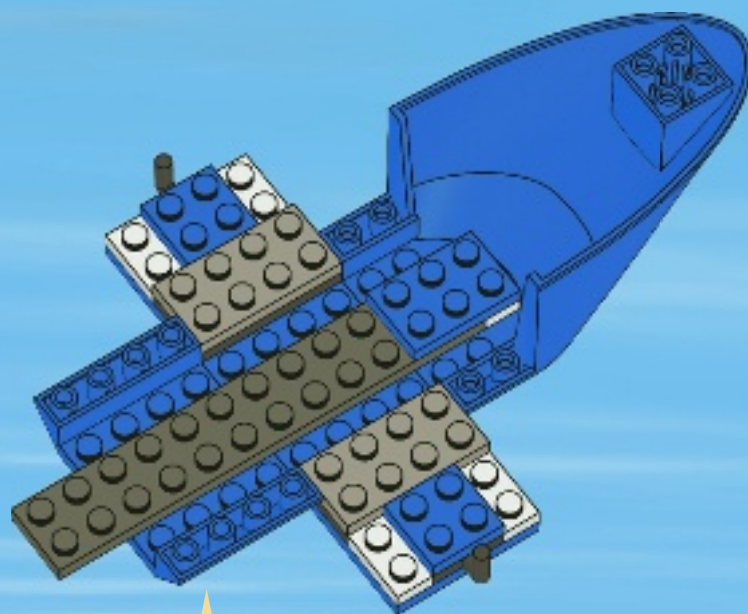

9

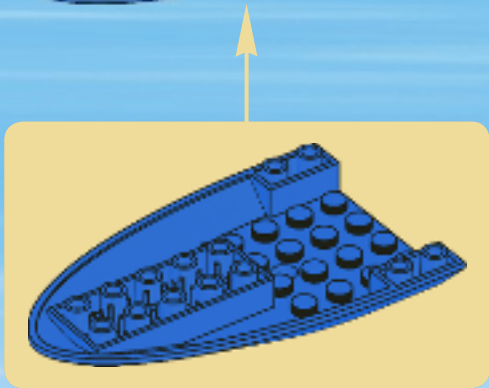
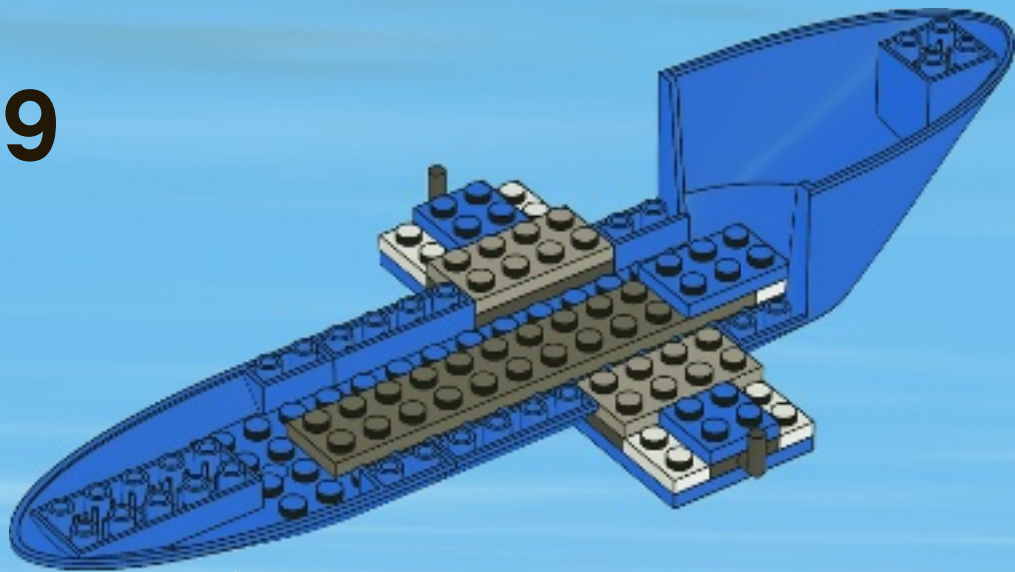

10

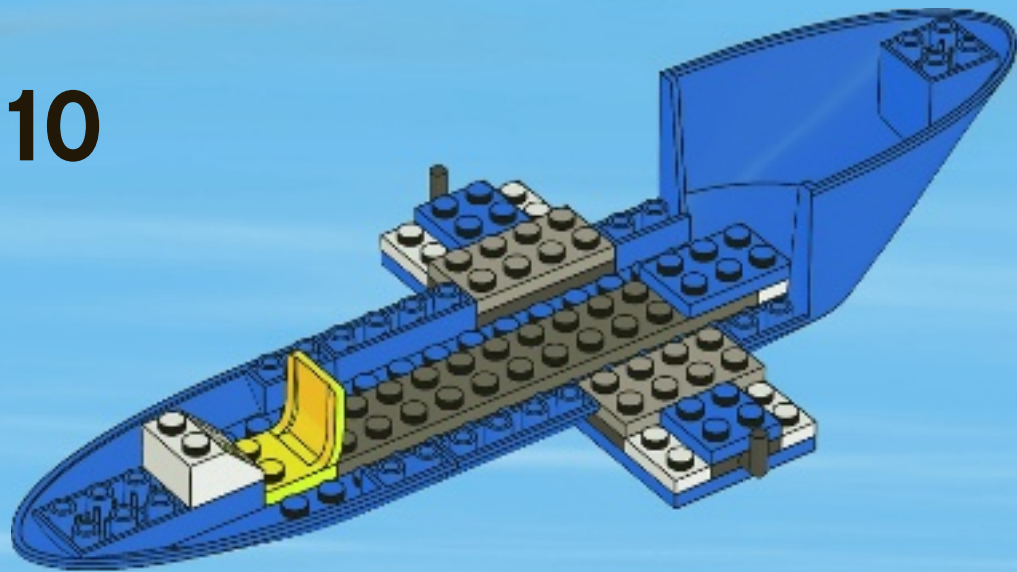



11

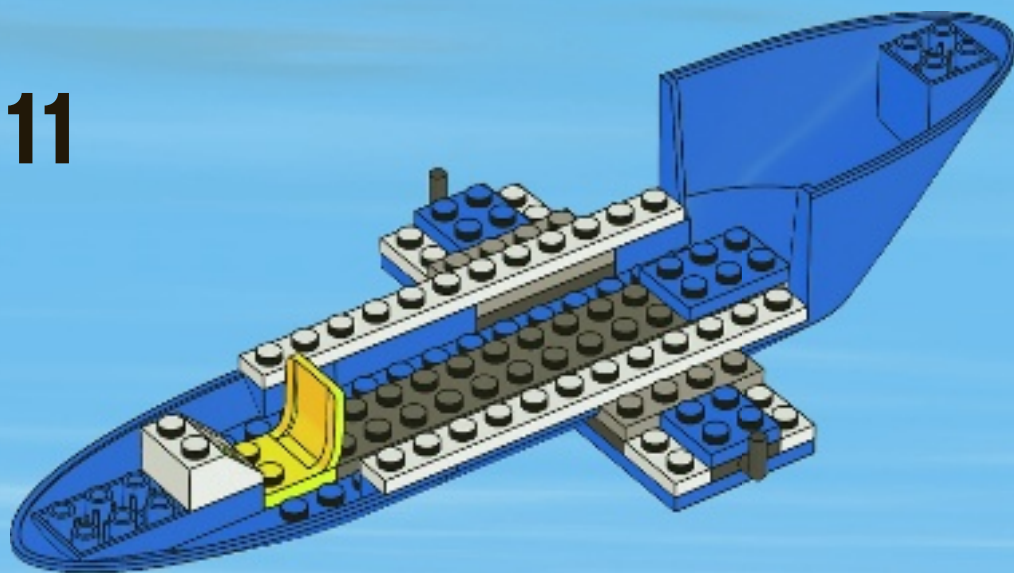

12

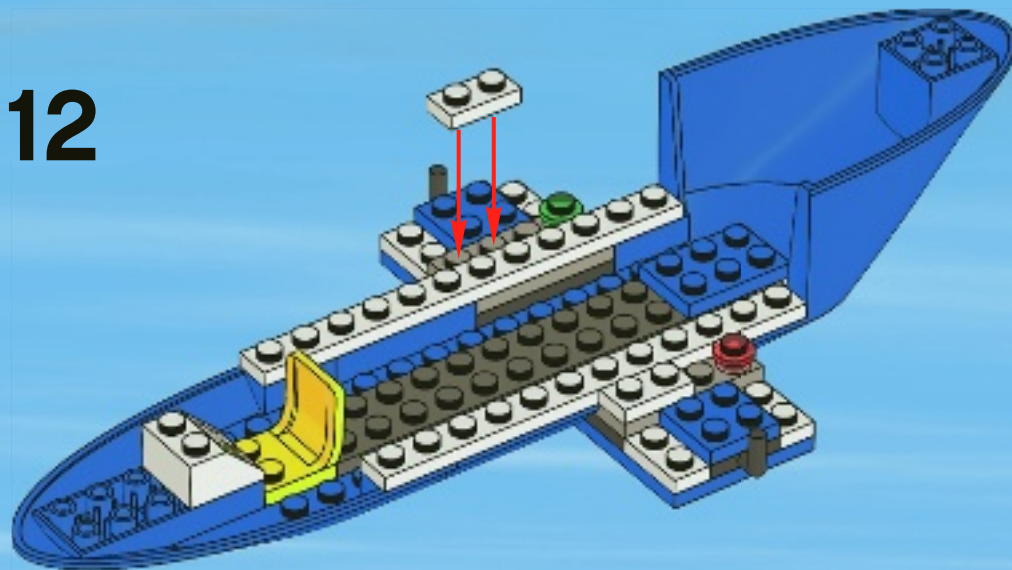

13

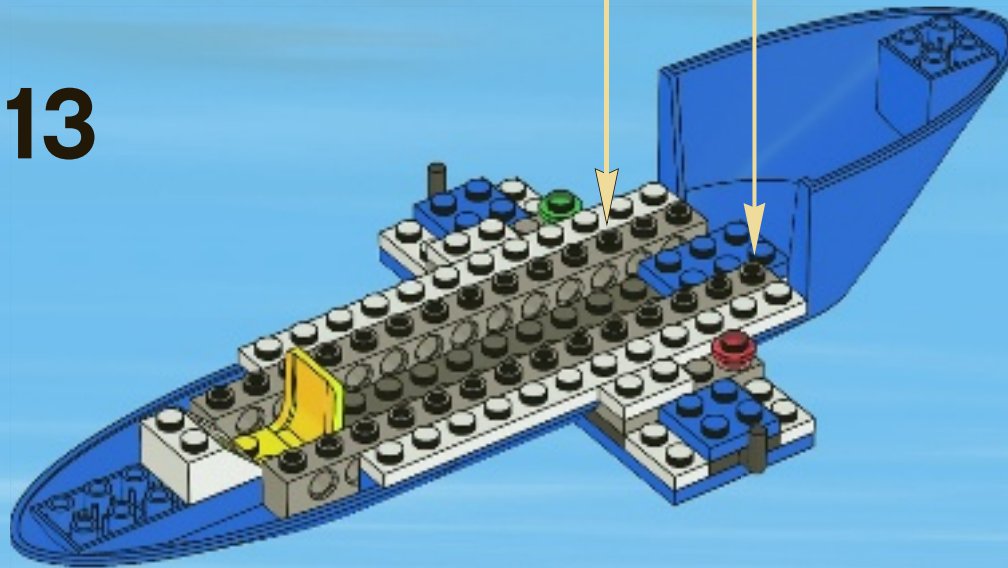
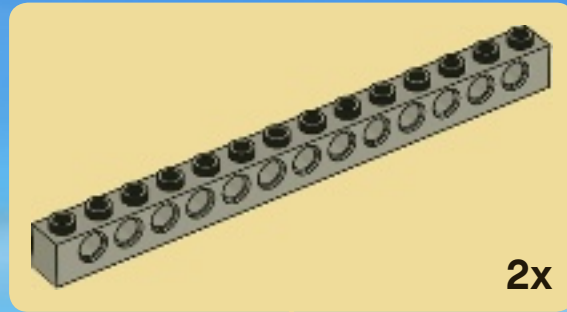



14

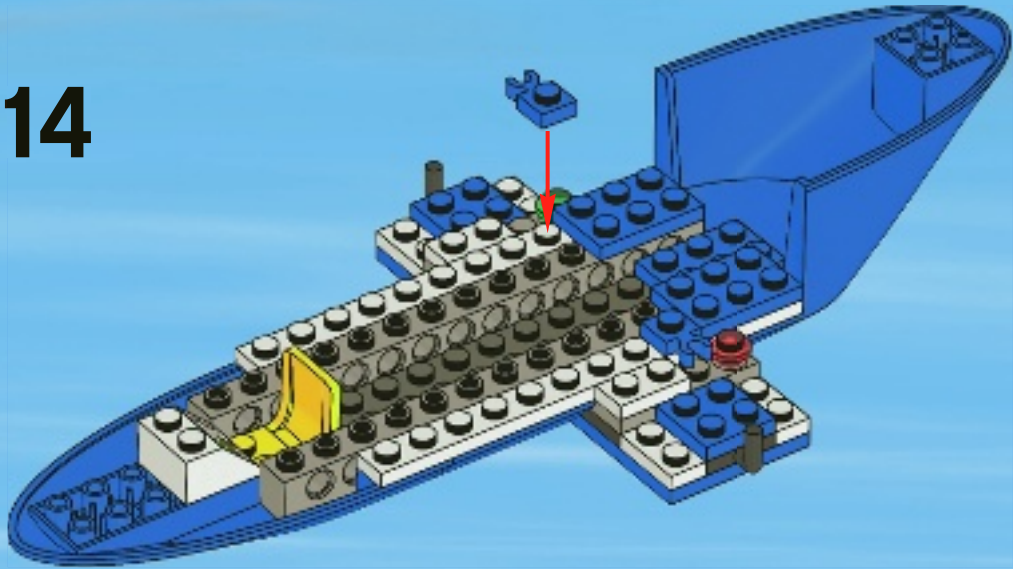

15

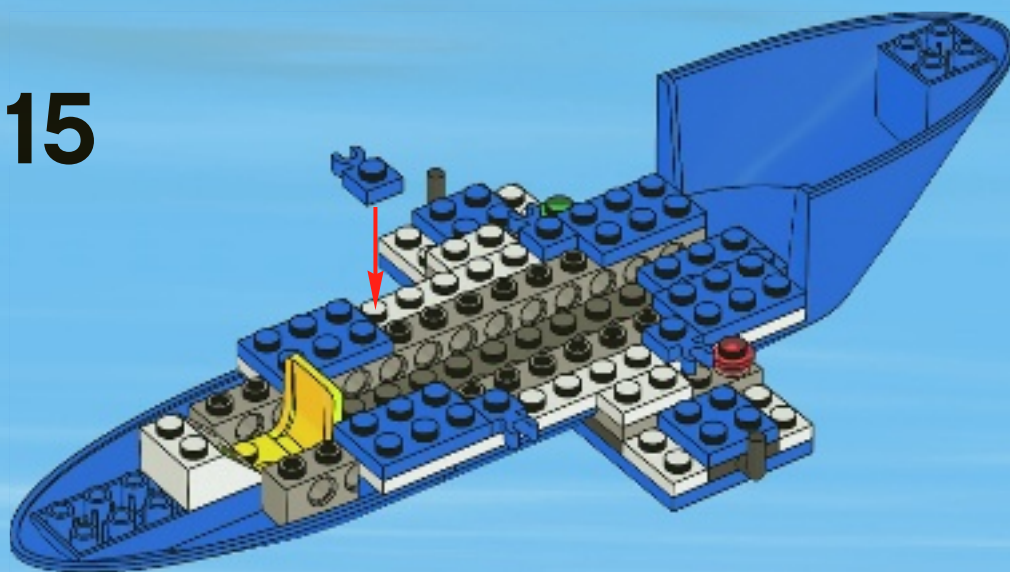

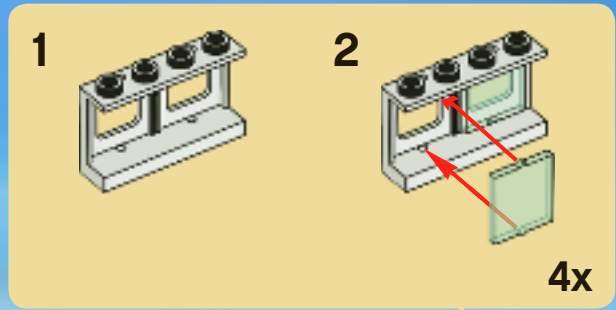

16

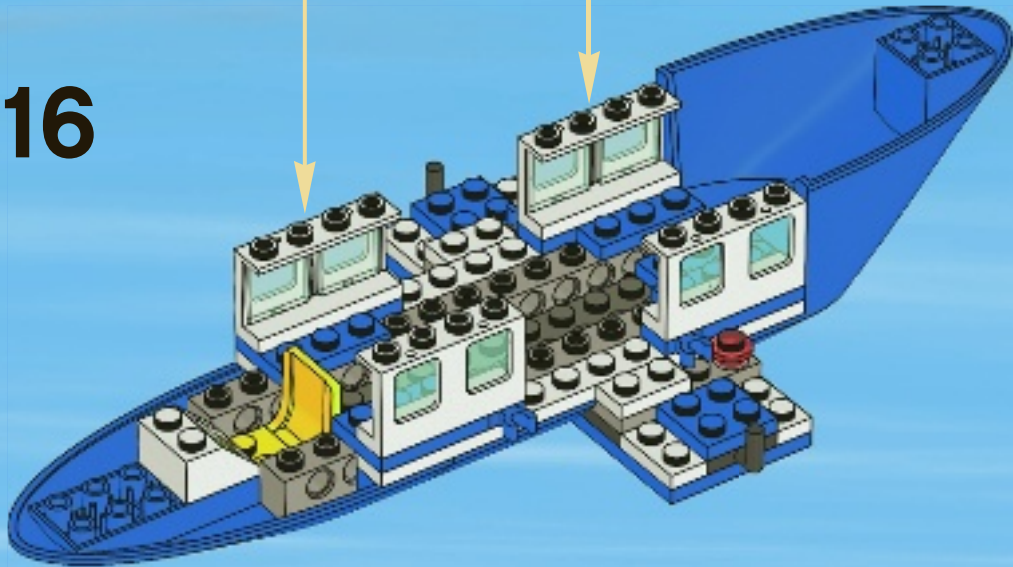

17

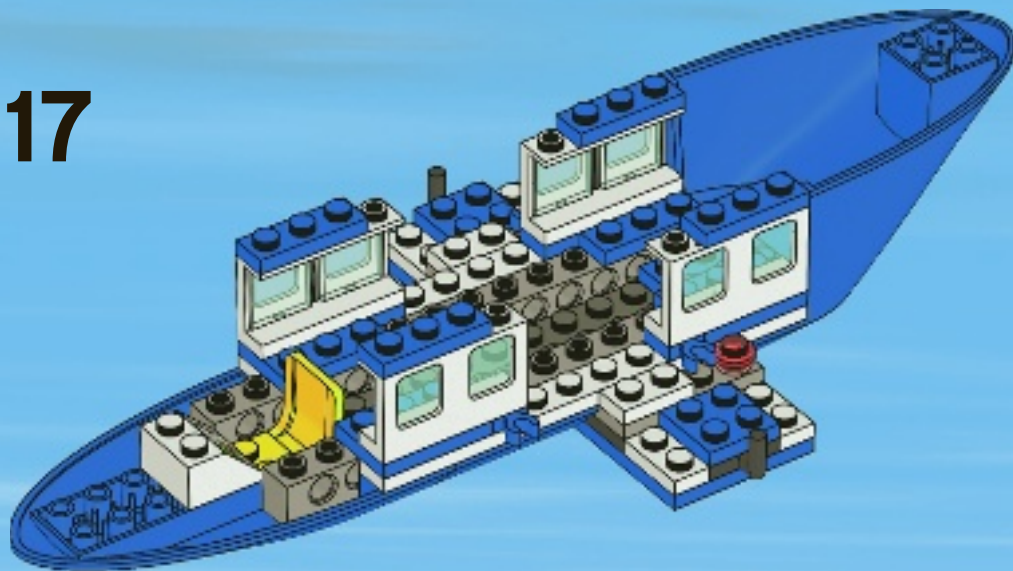

18

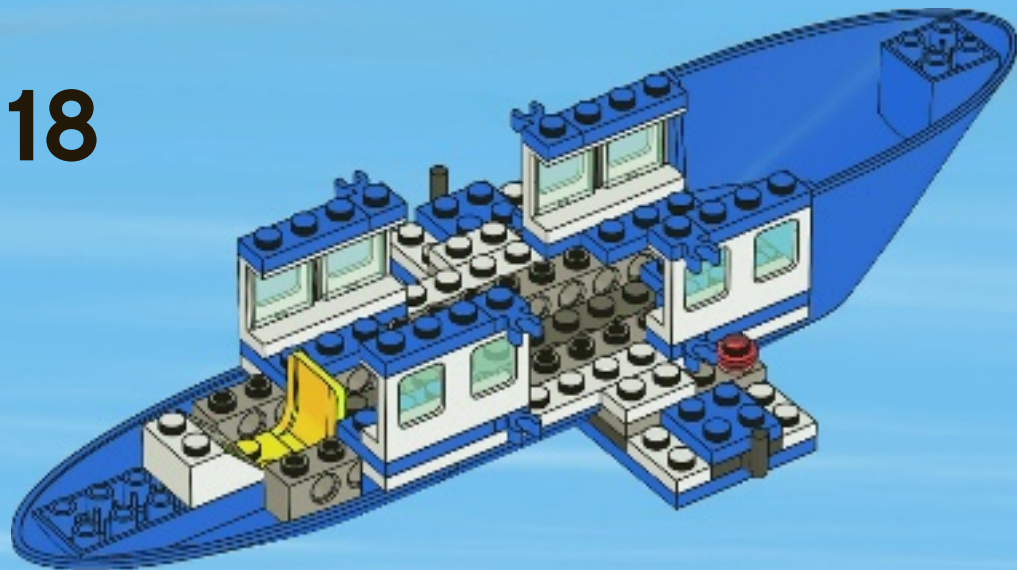



19

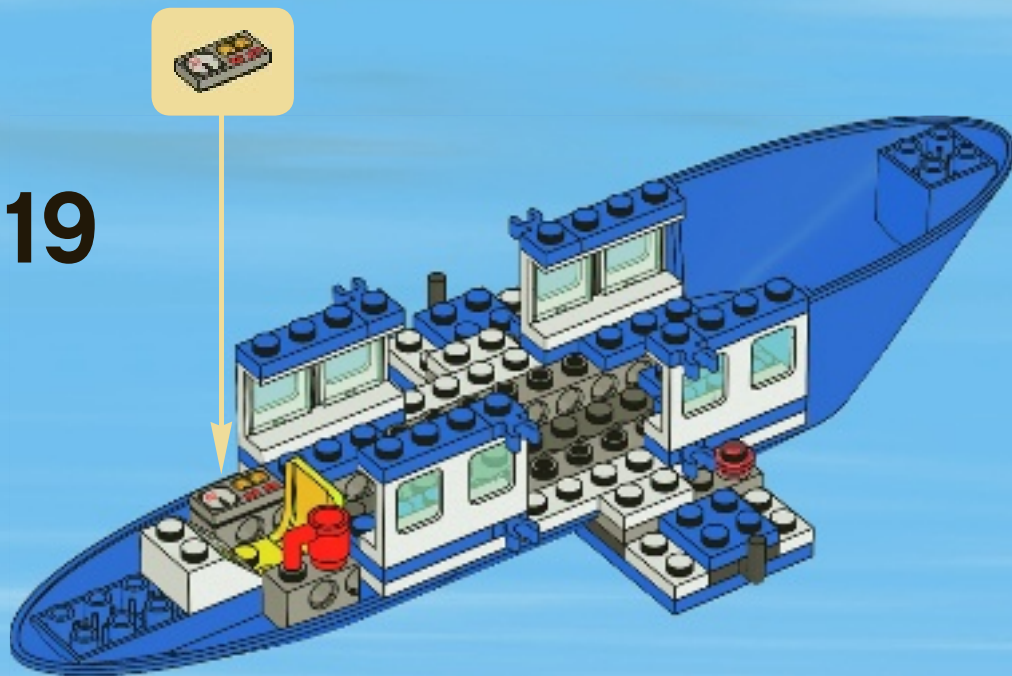

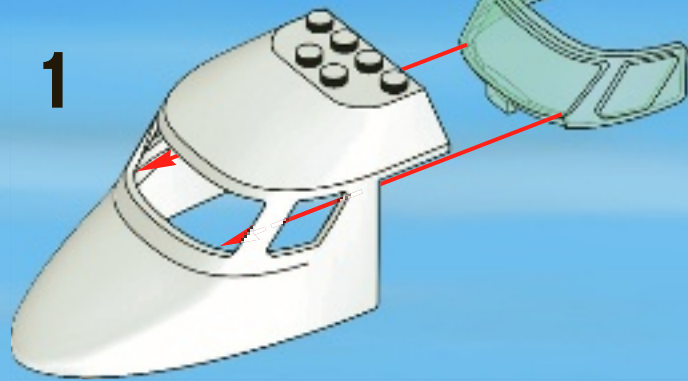

**20**

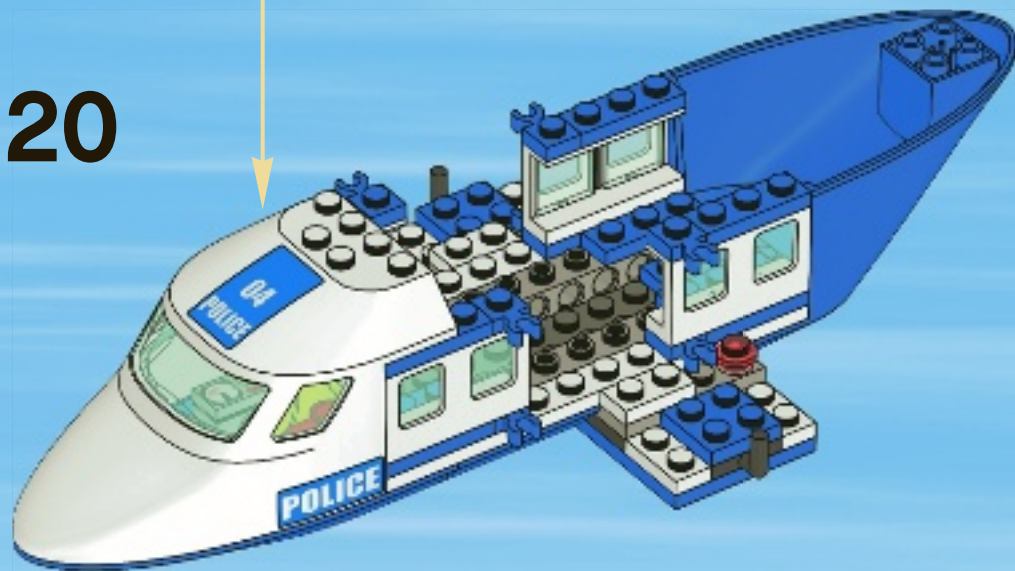

21



1

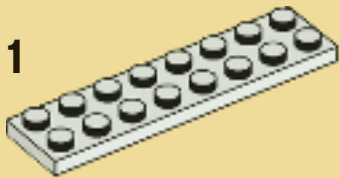

2

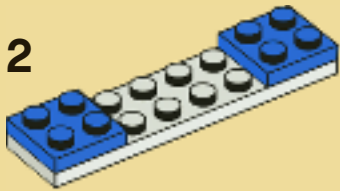

22

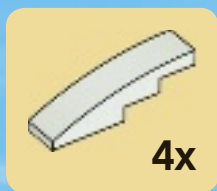



23

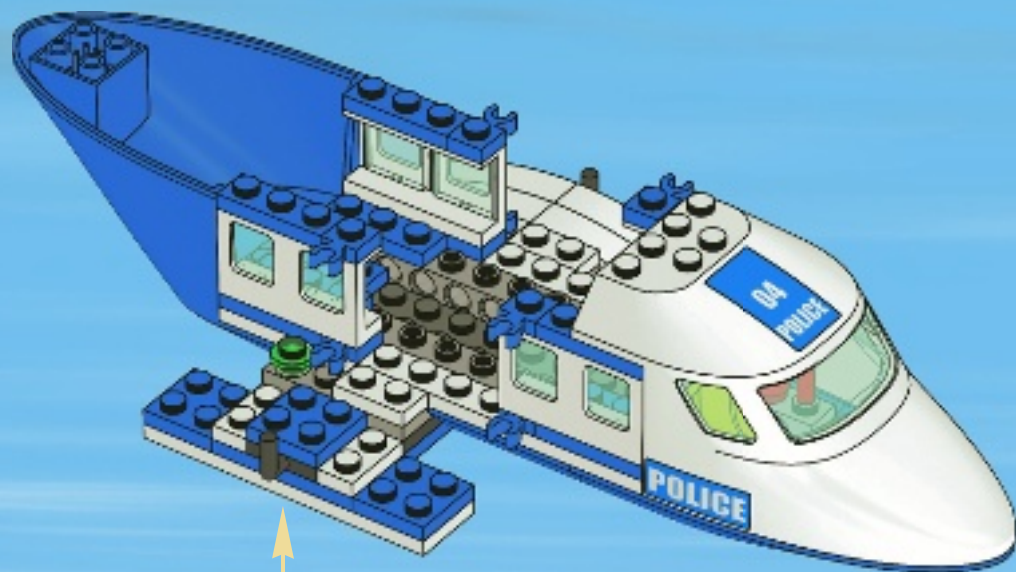

1

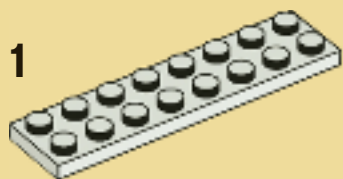

2

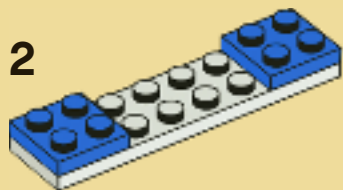



24

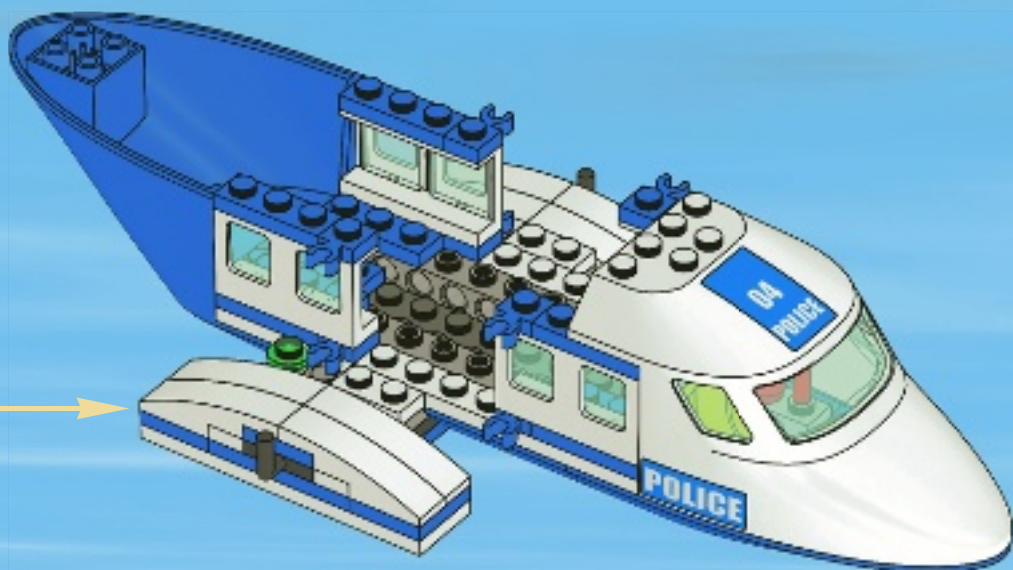
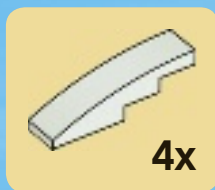



25



26



27





28





29

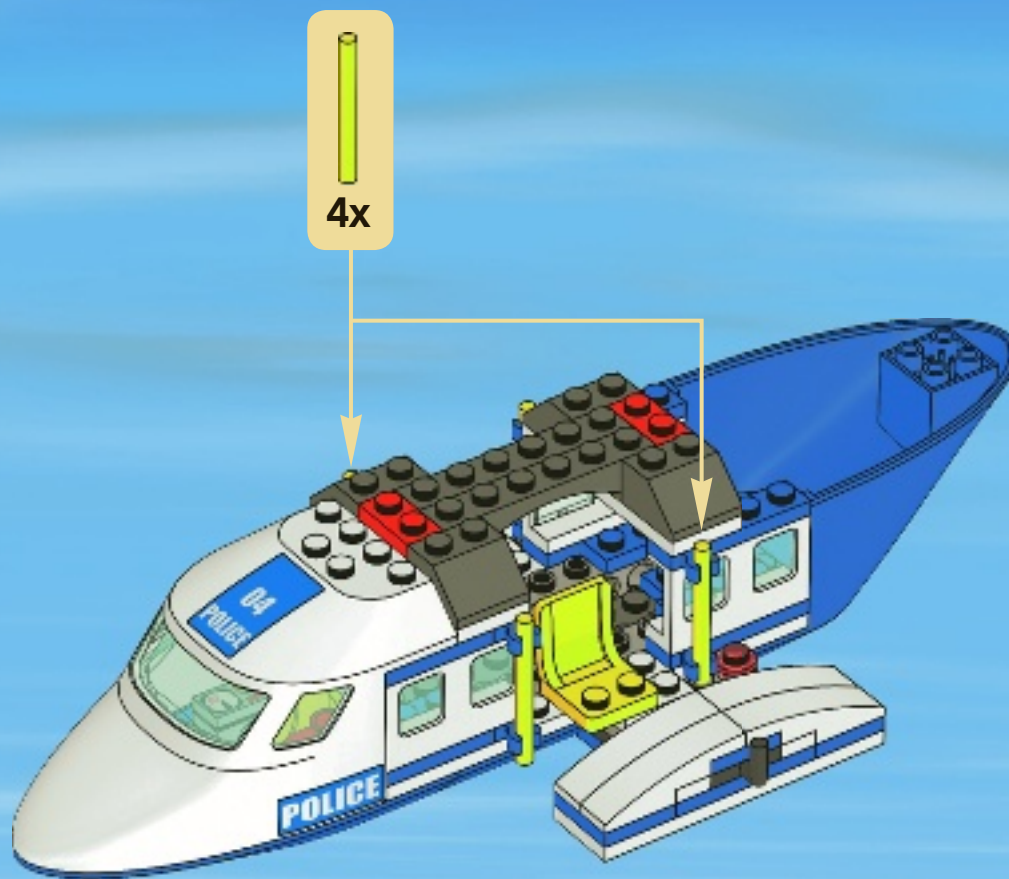



**1**

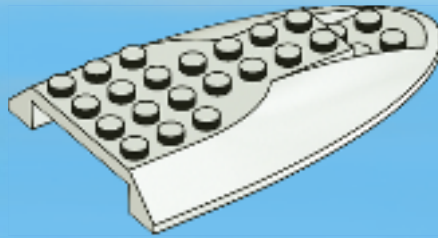

**2**

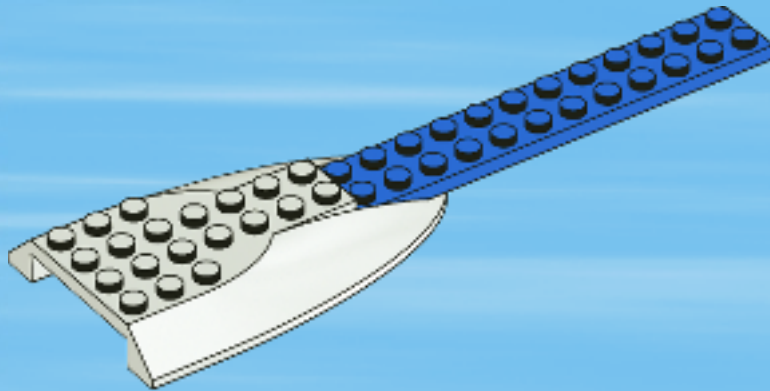

3

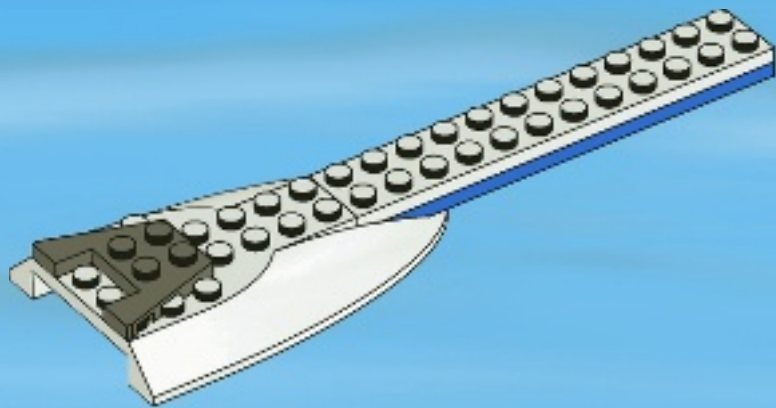

4

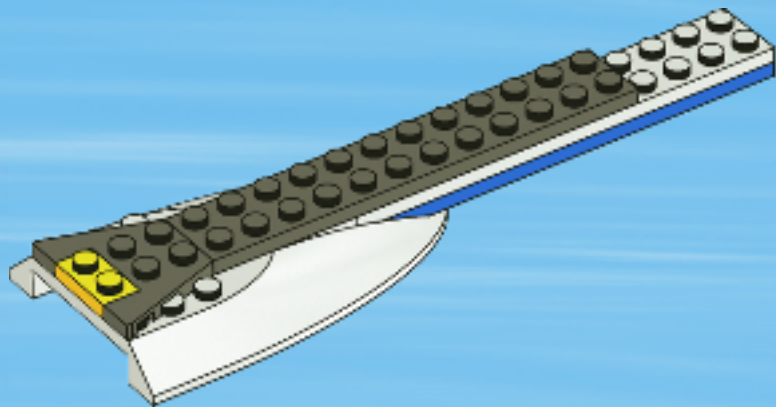

29

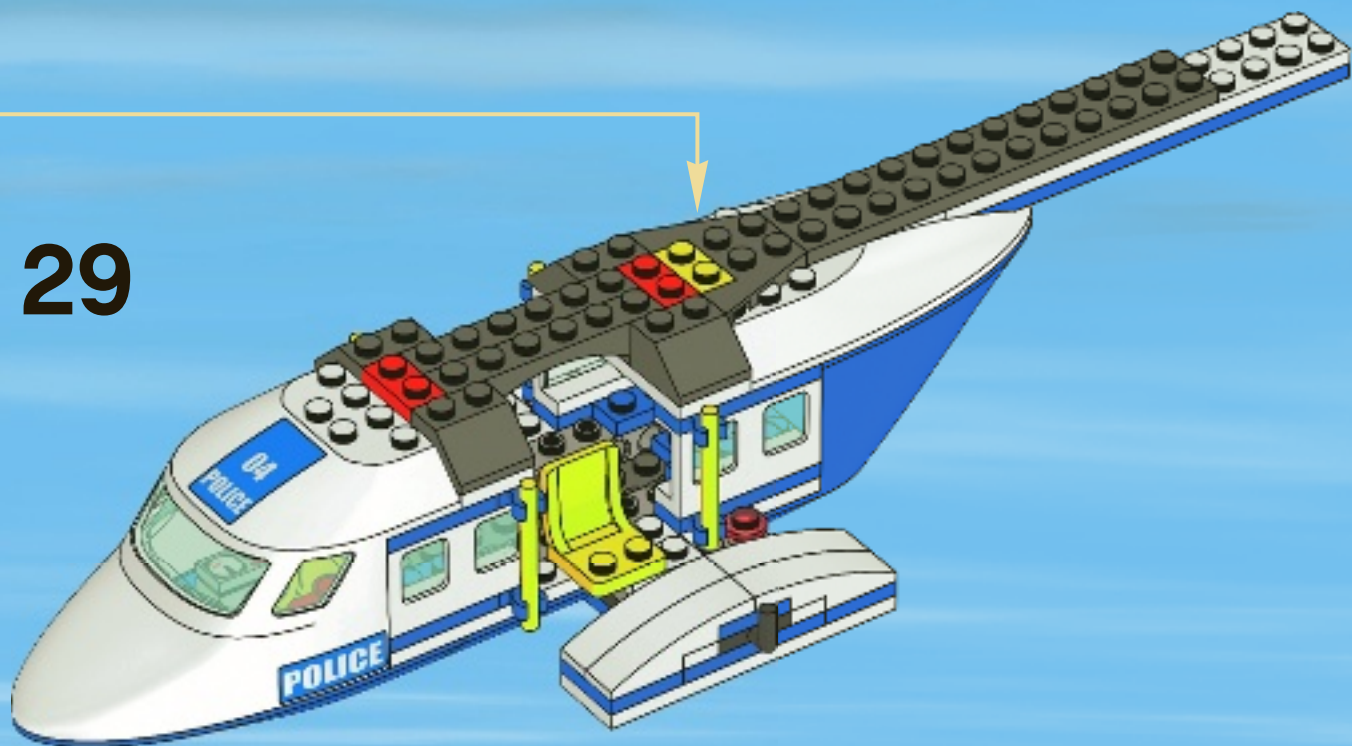

31

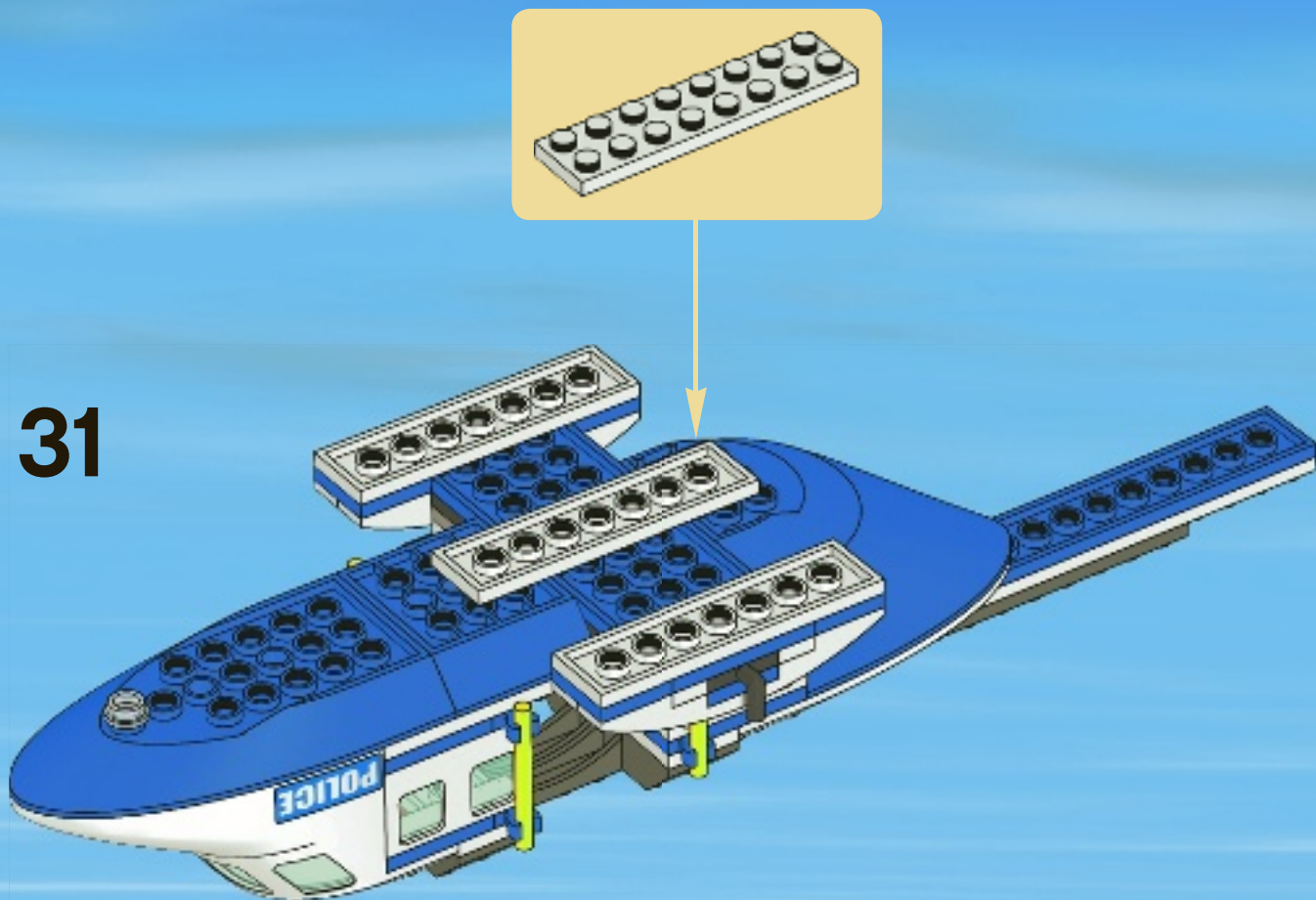



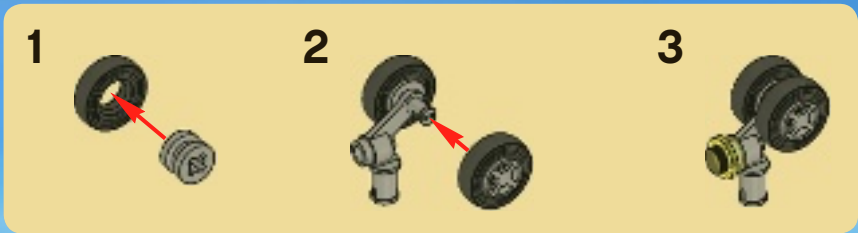

32

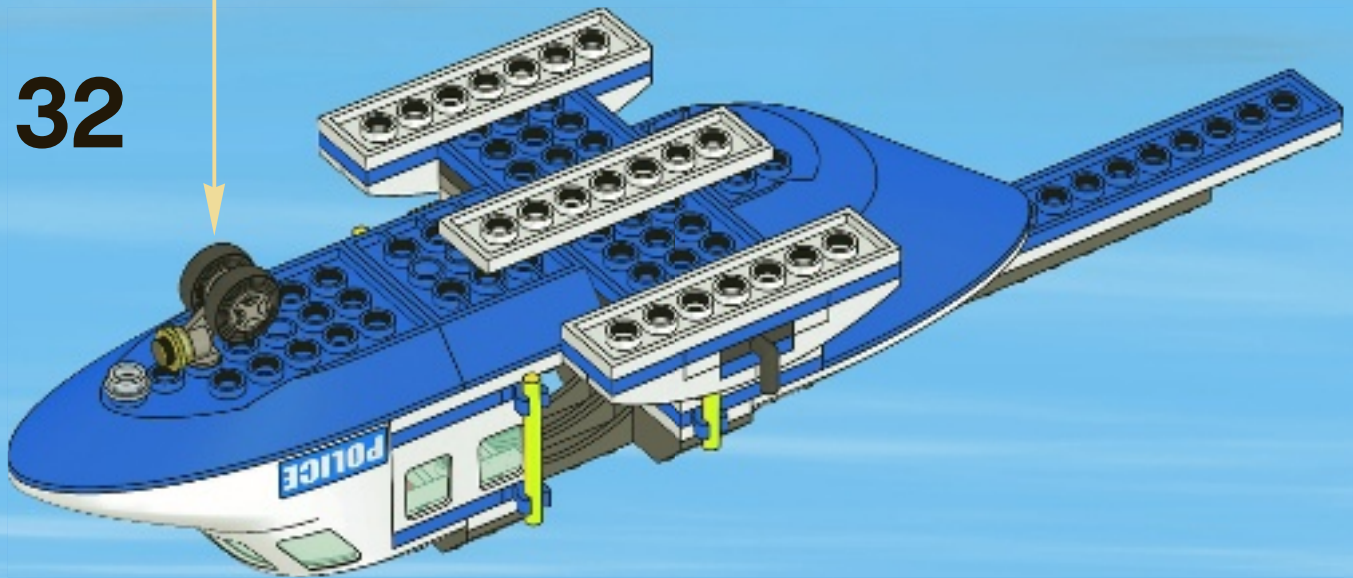

33

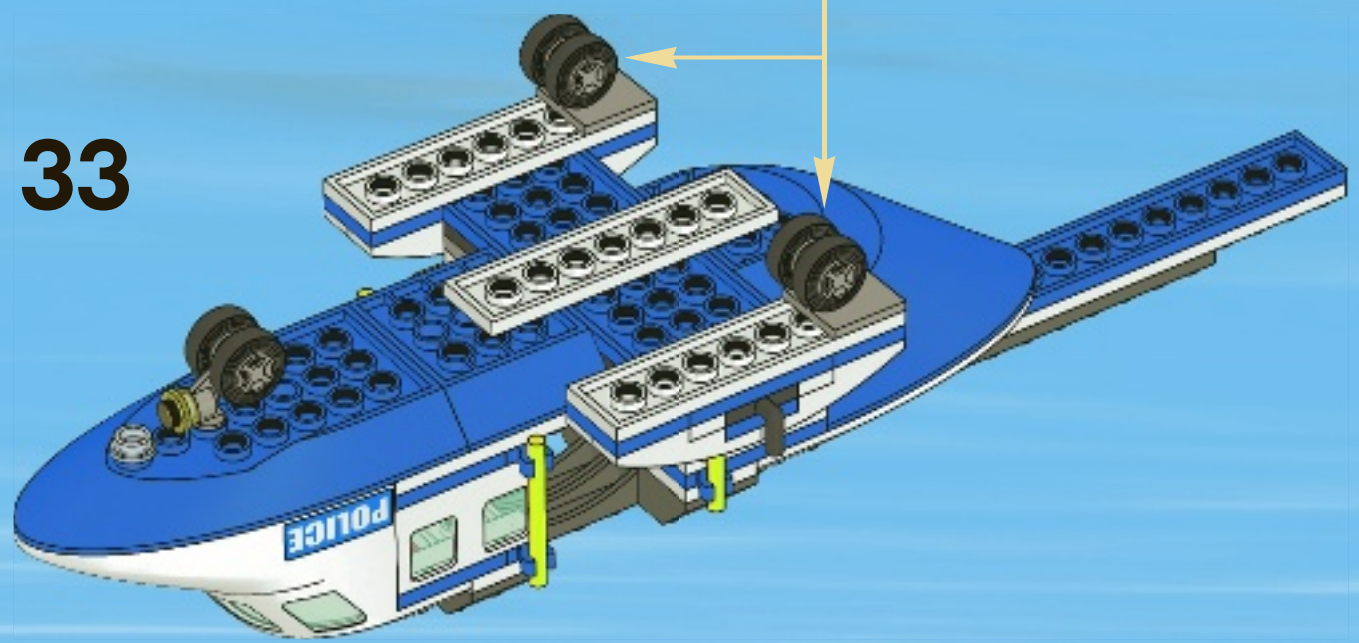
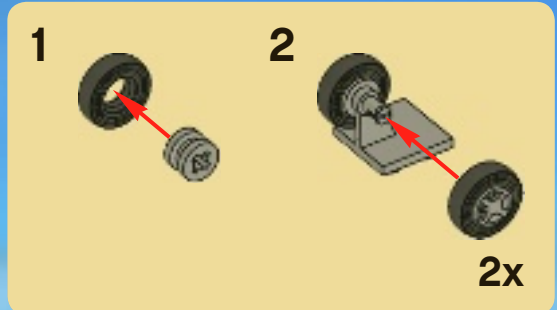

34

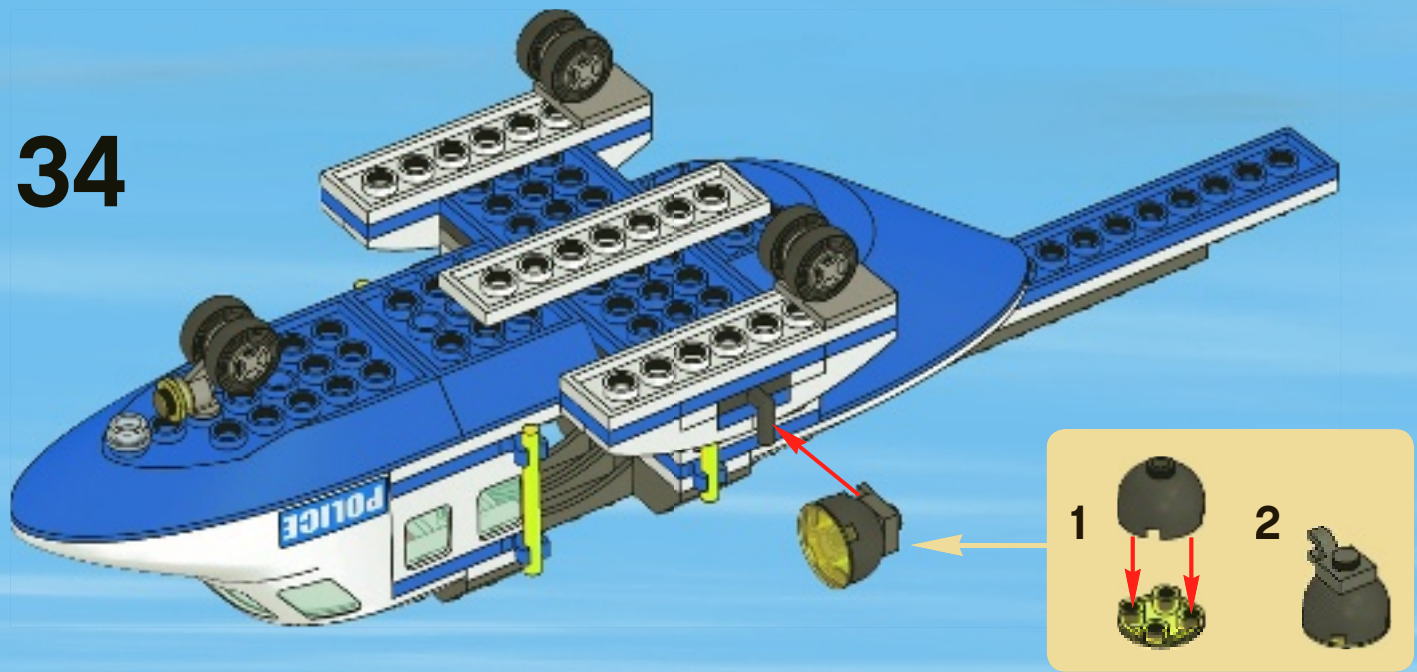

1



2



3



35

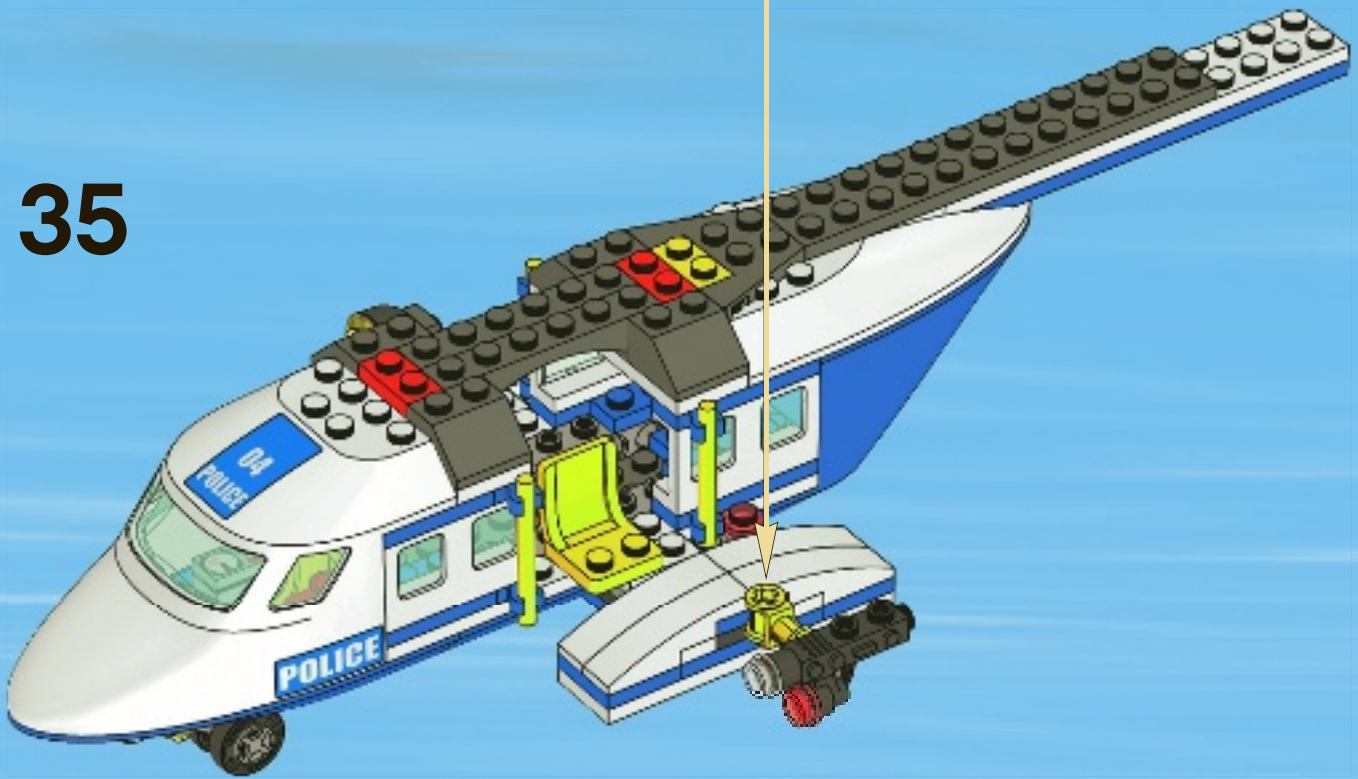



36

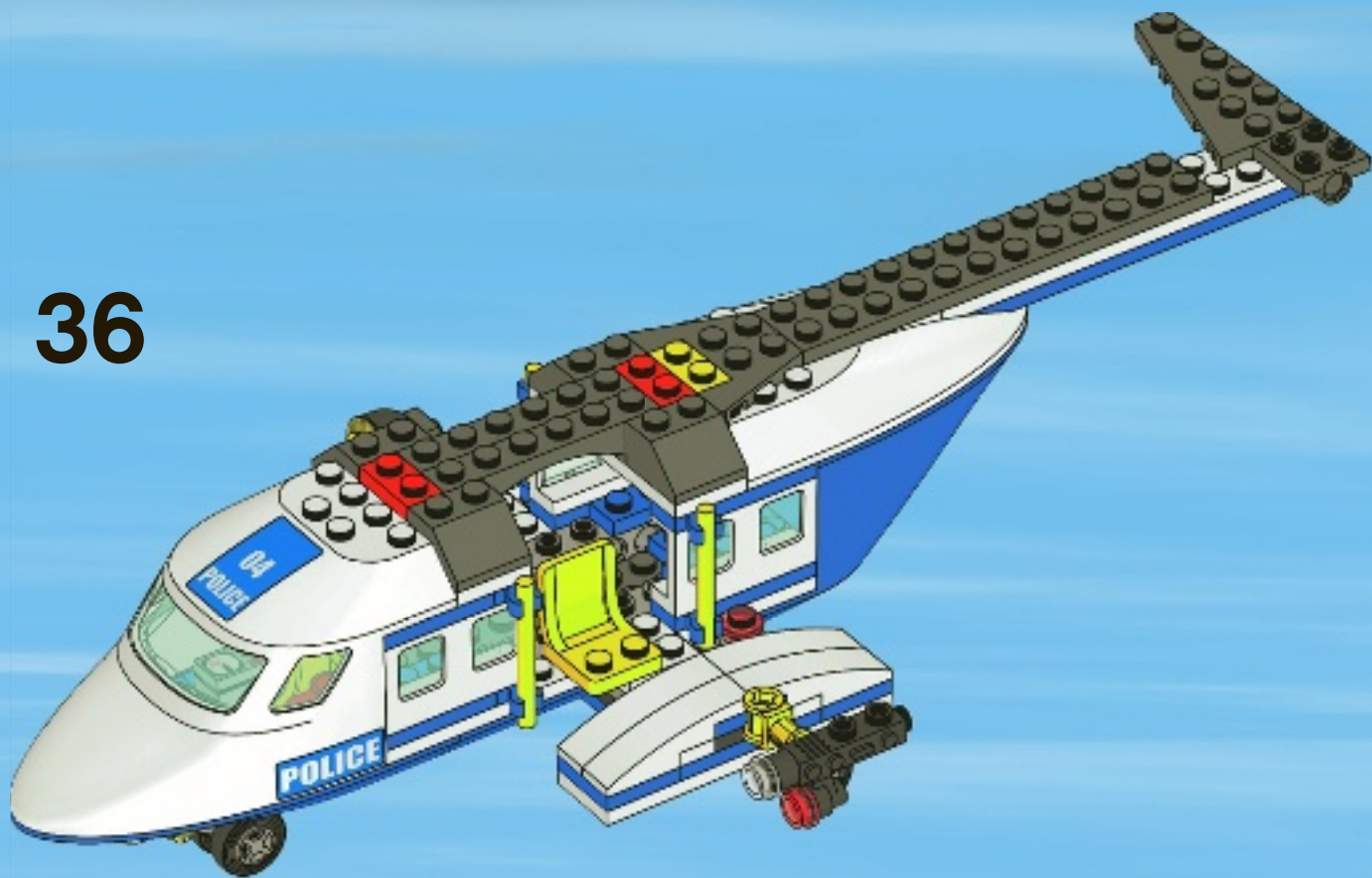



37

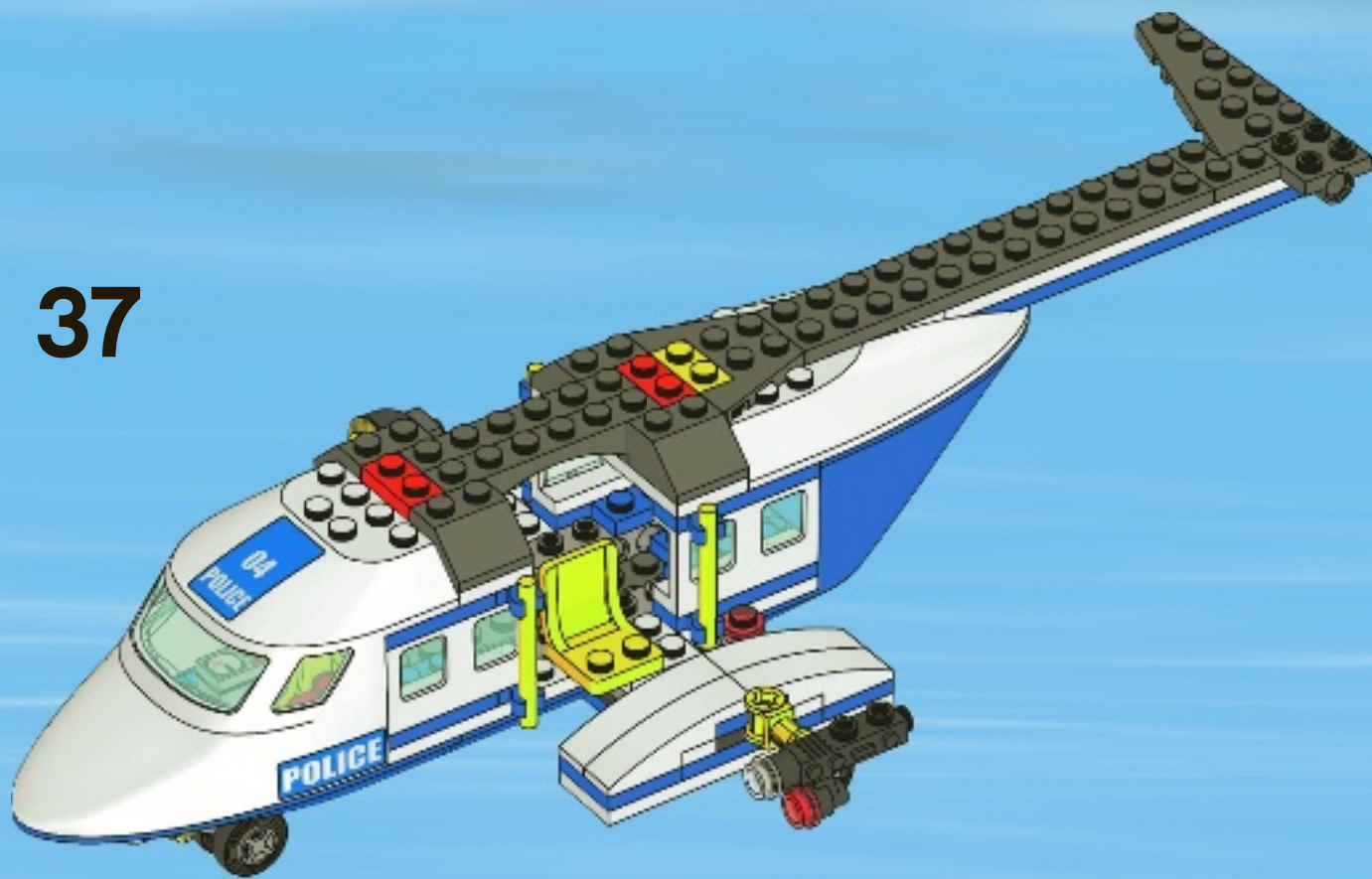

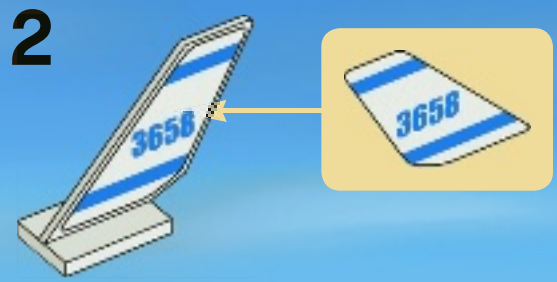
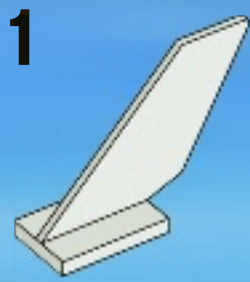

38



39

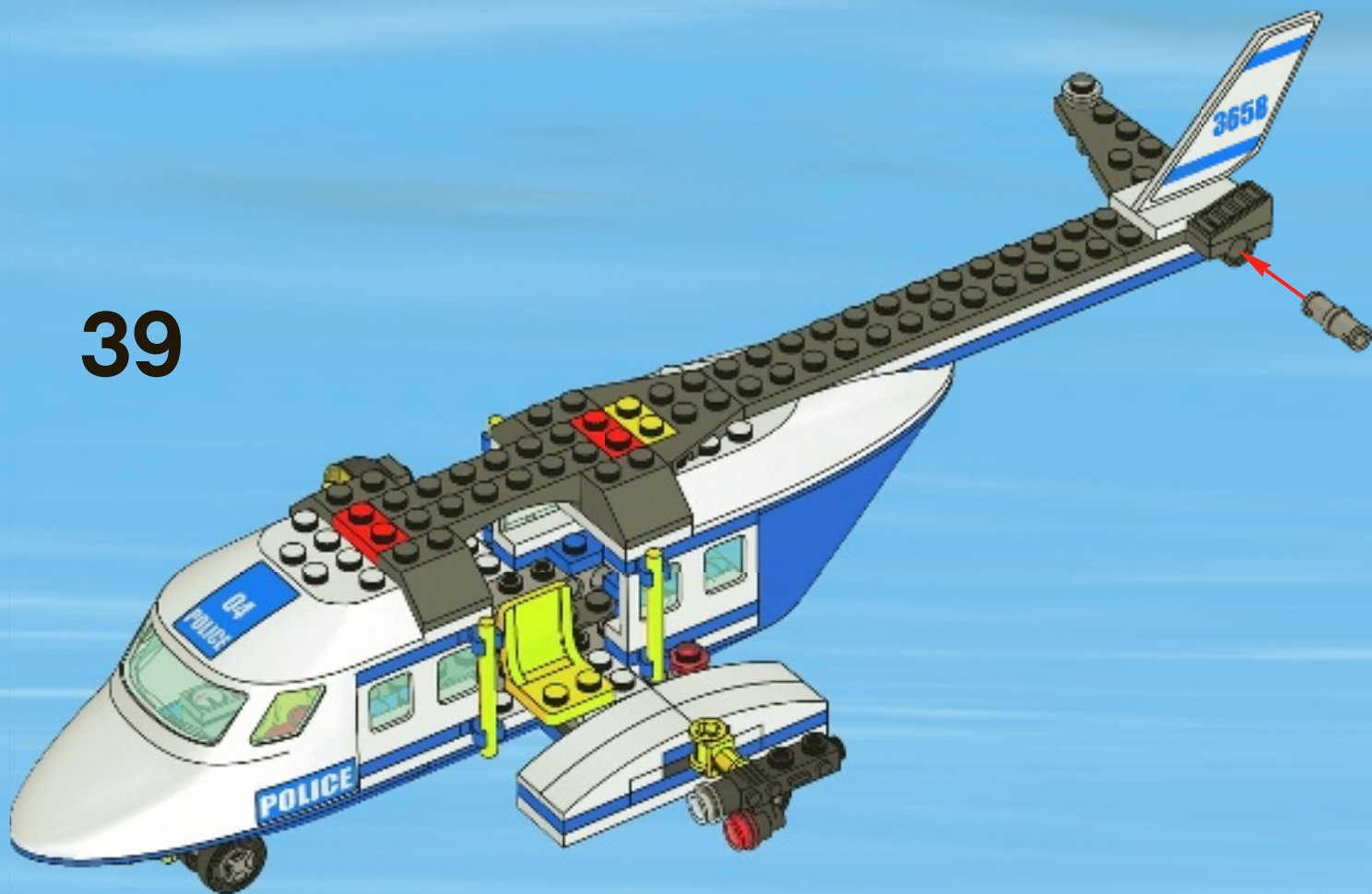

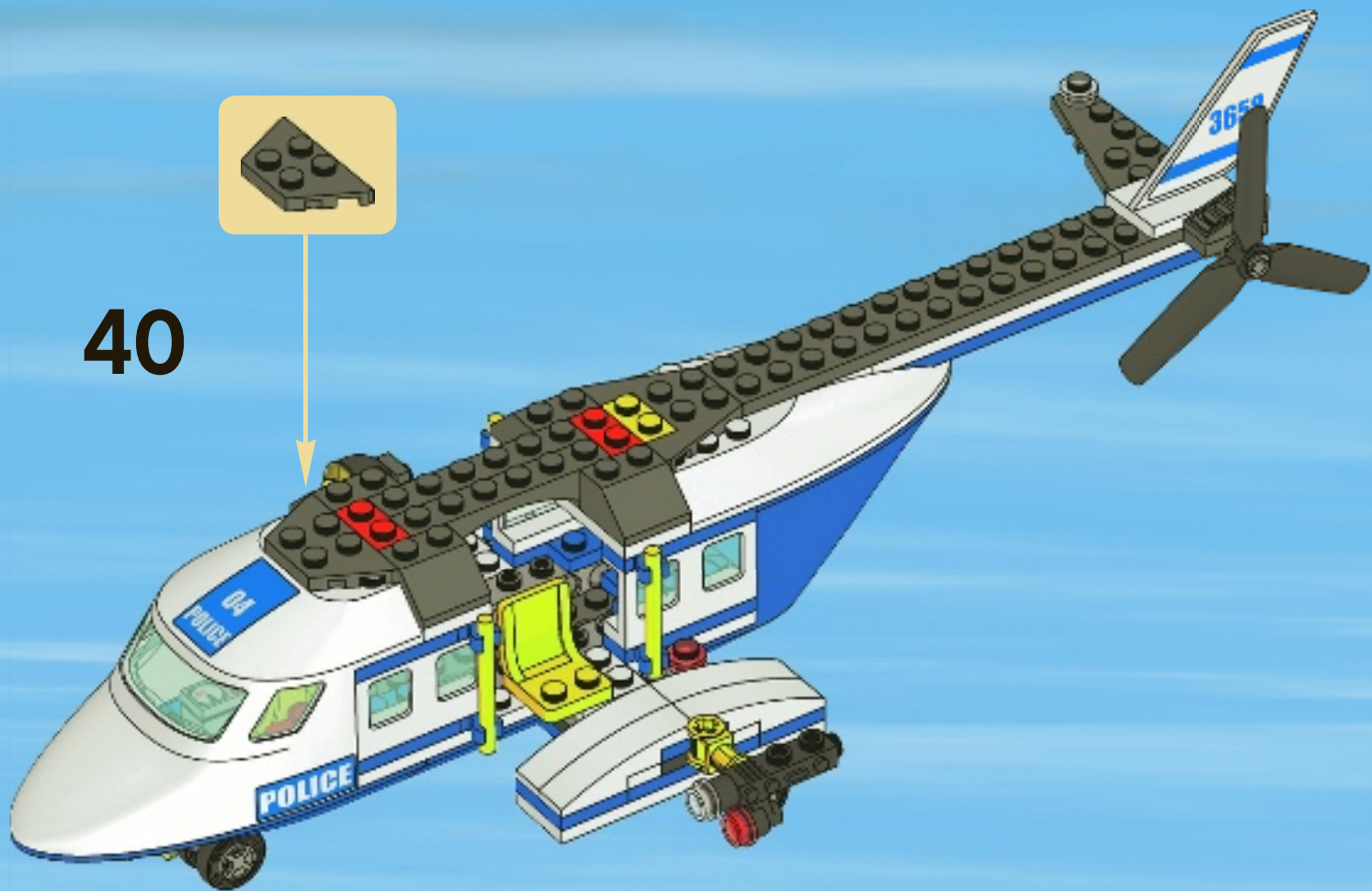

40



41

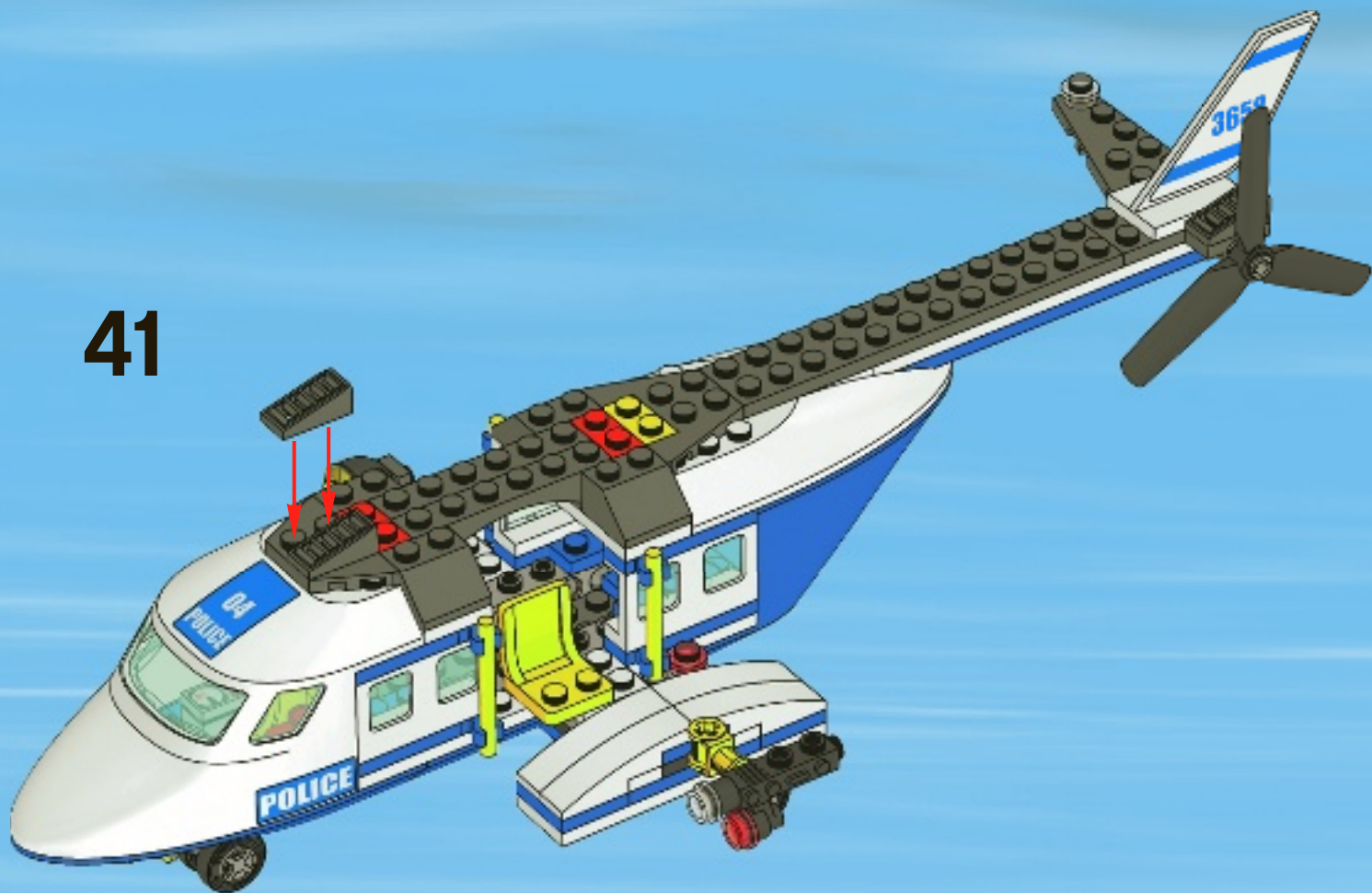



42

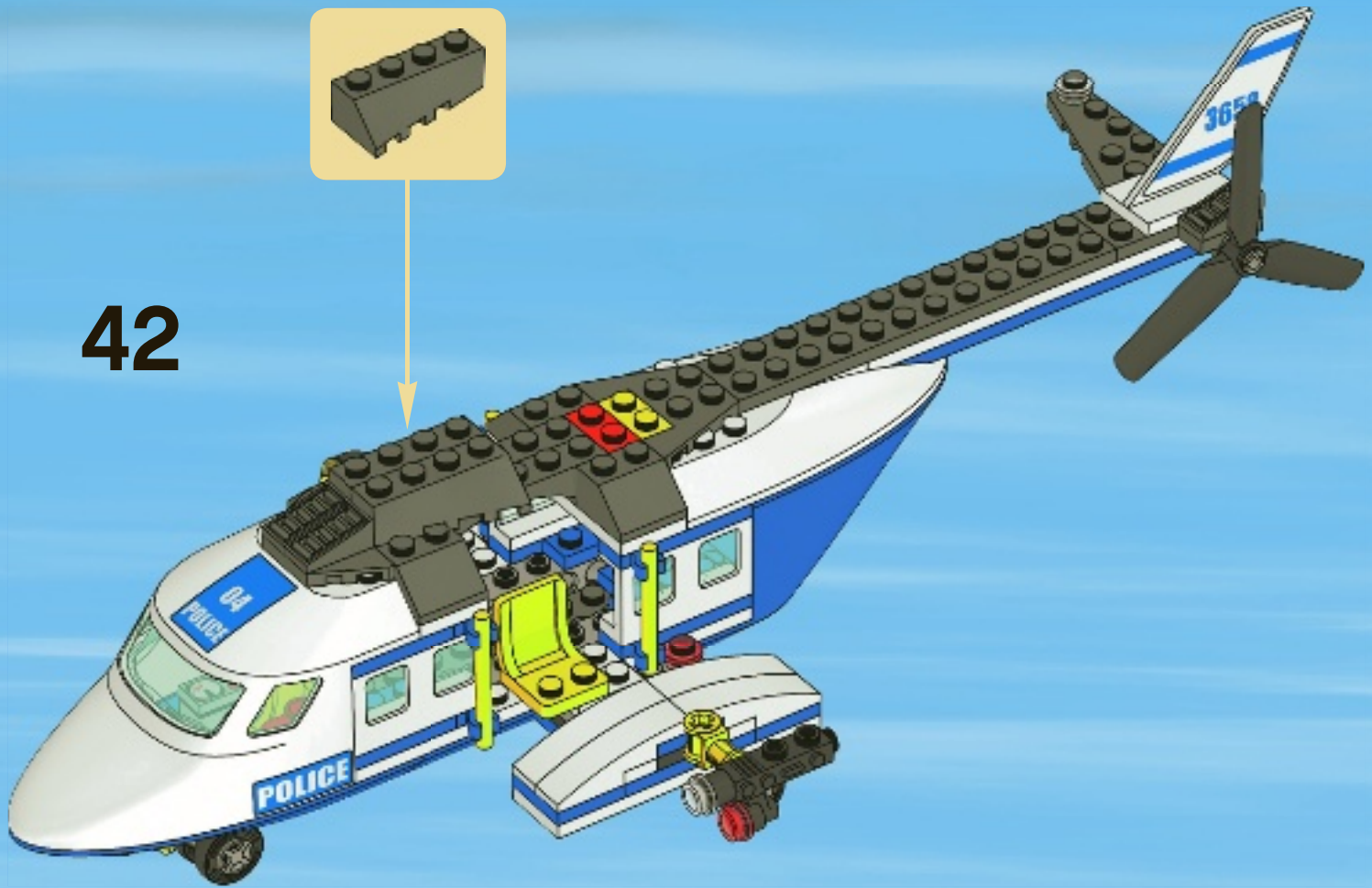
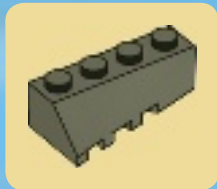

43

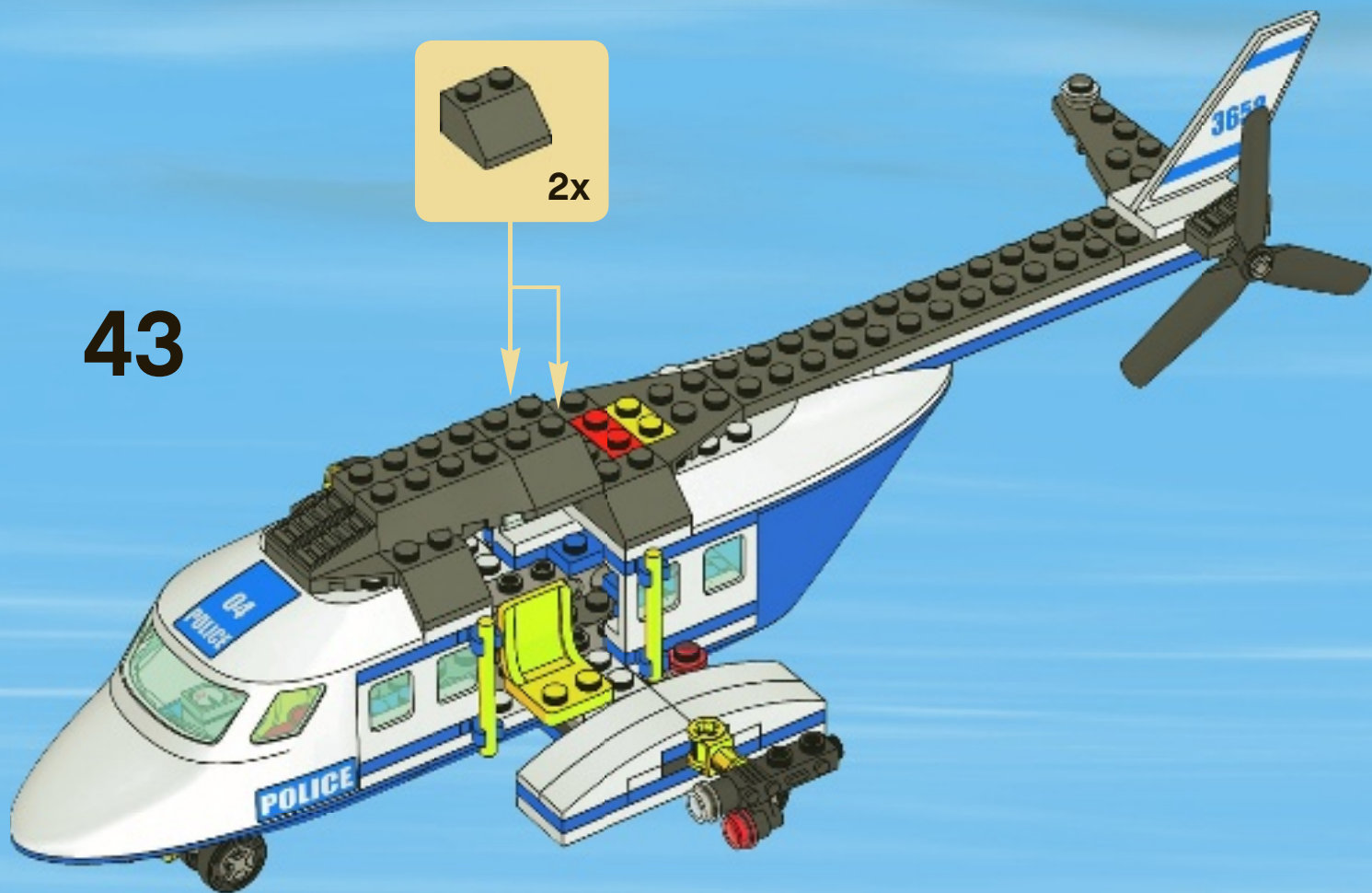

44

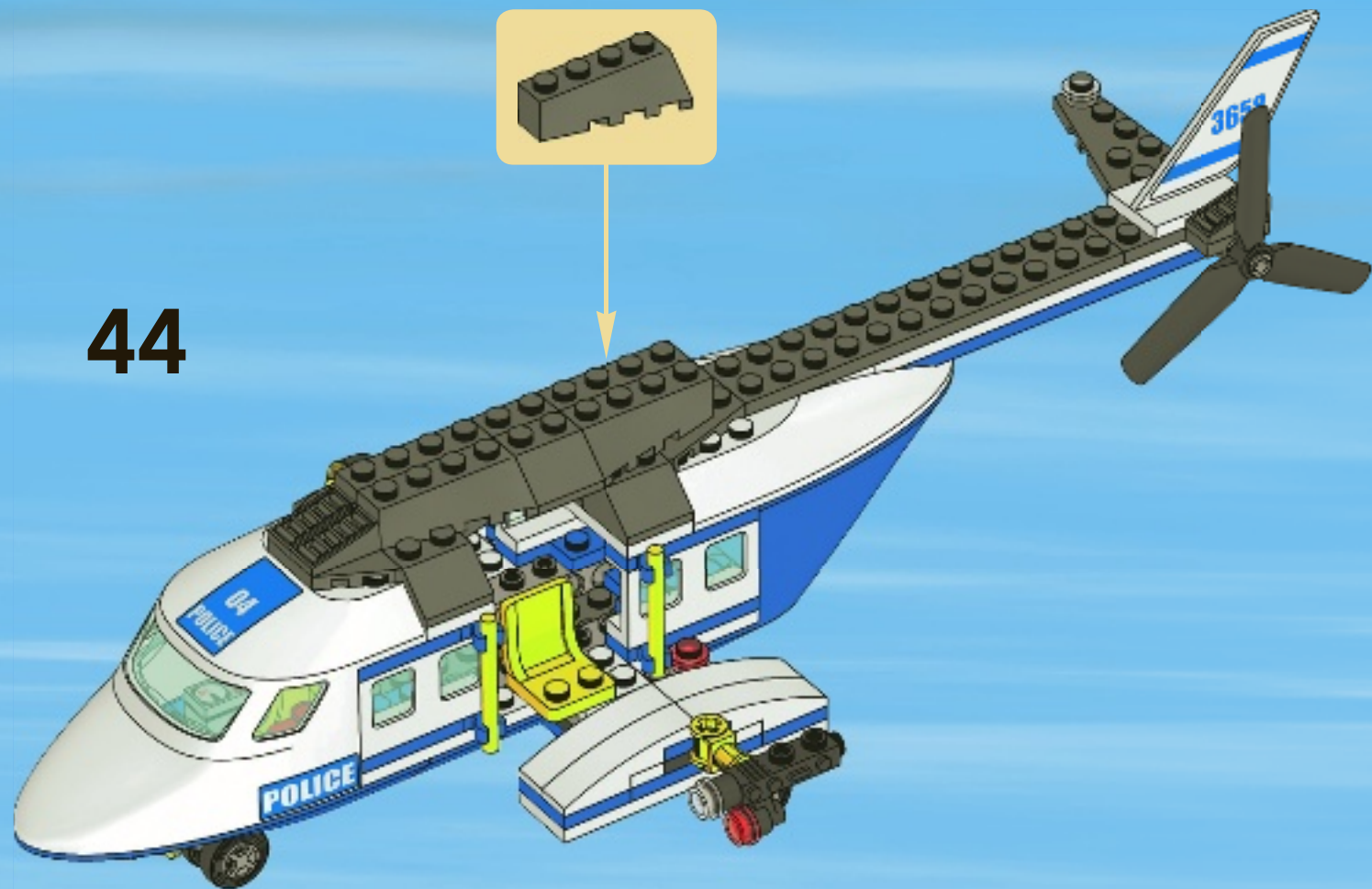

45

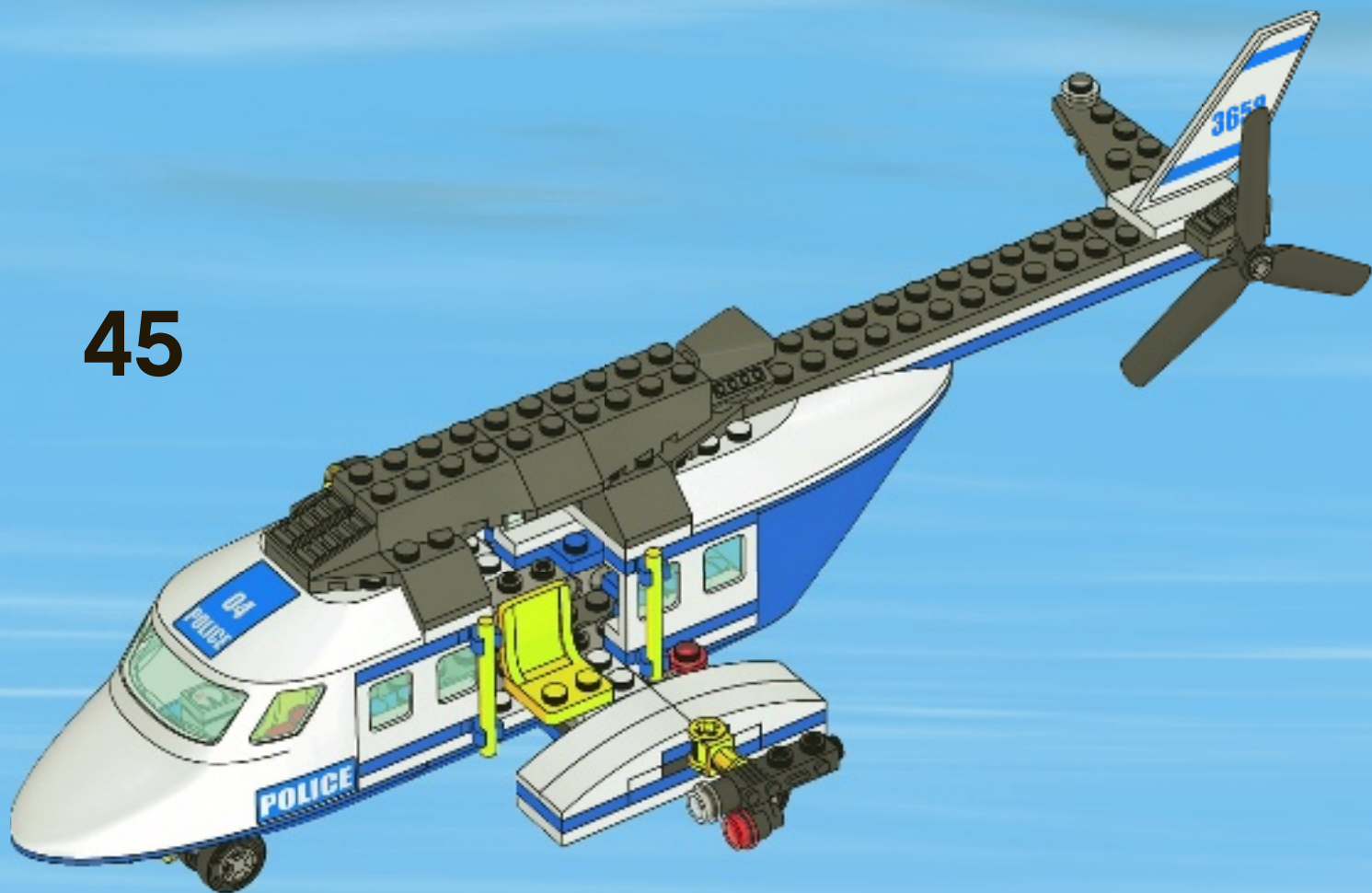



46

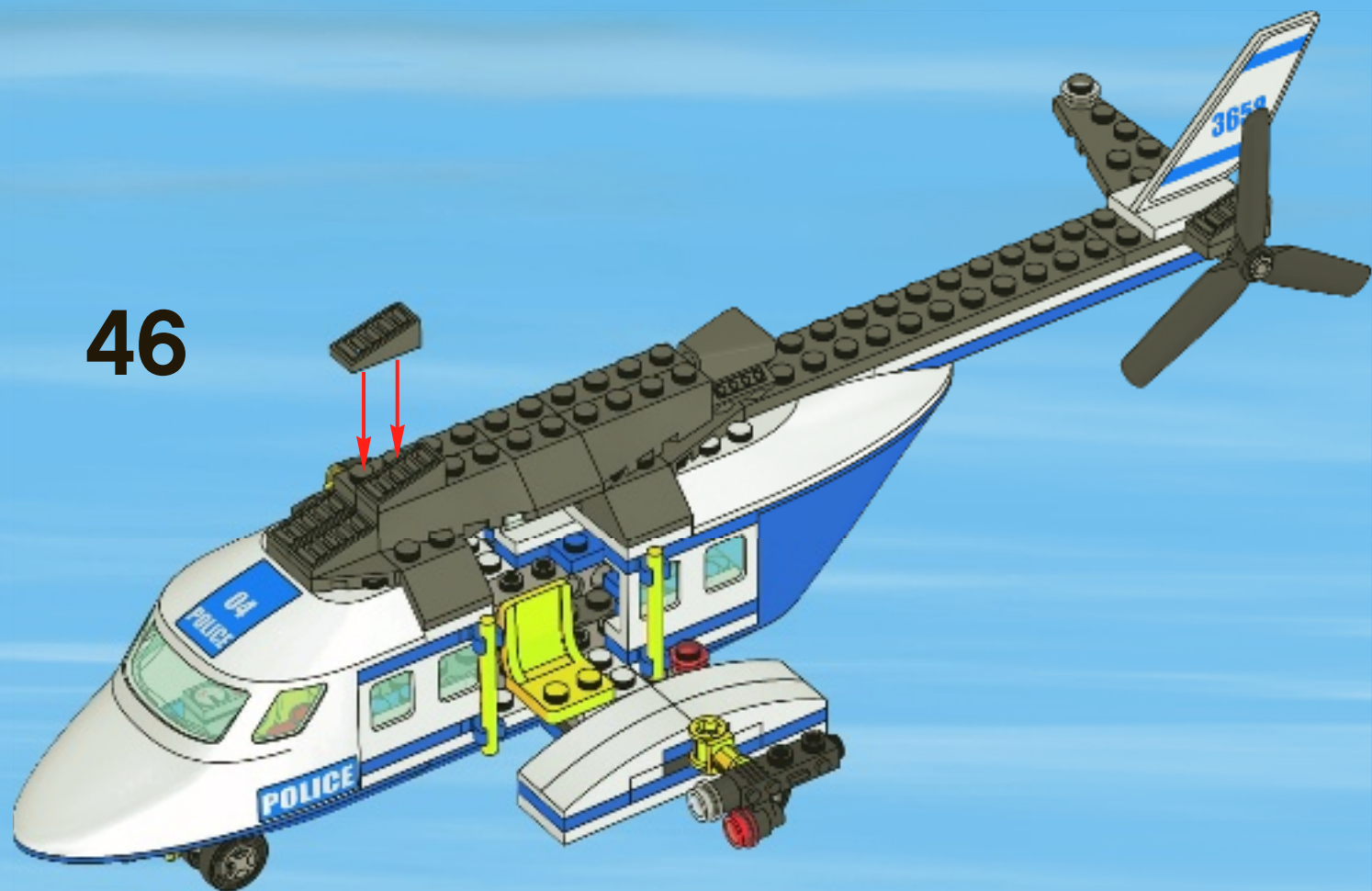



47

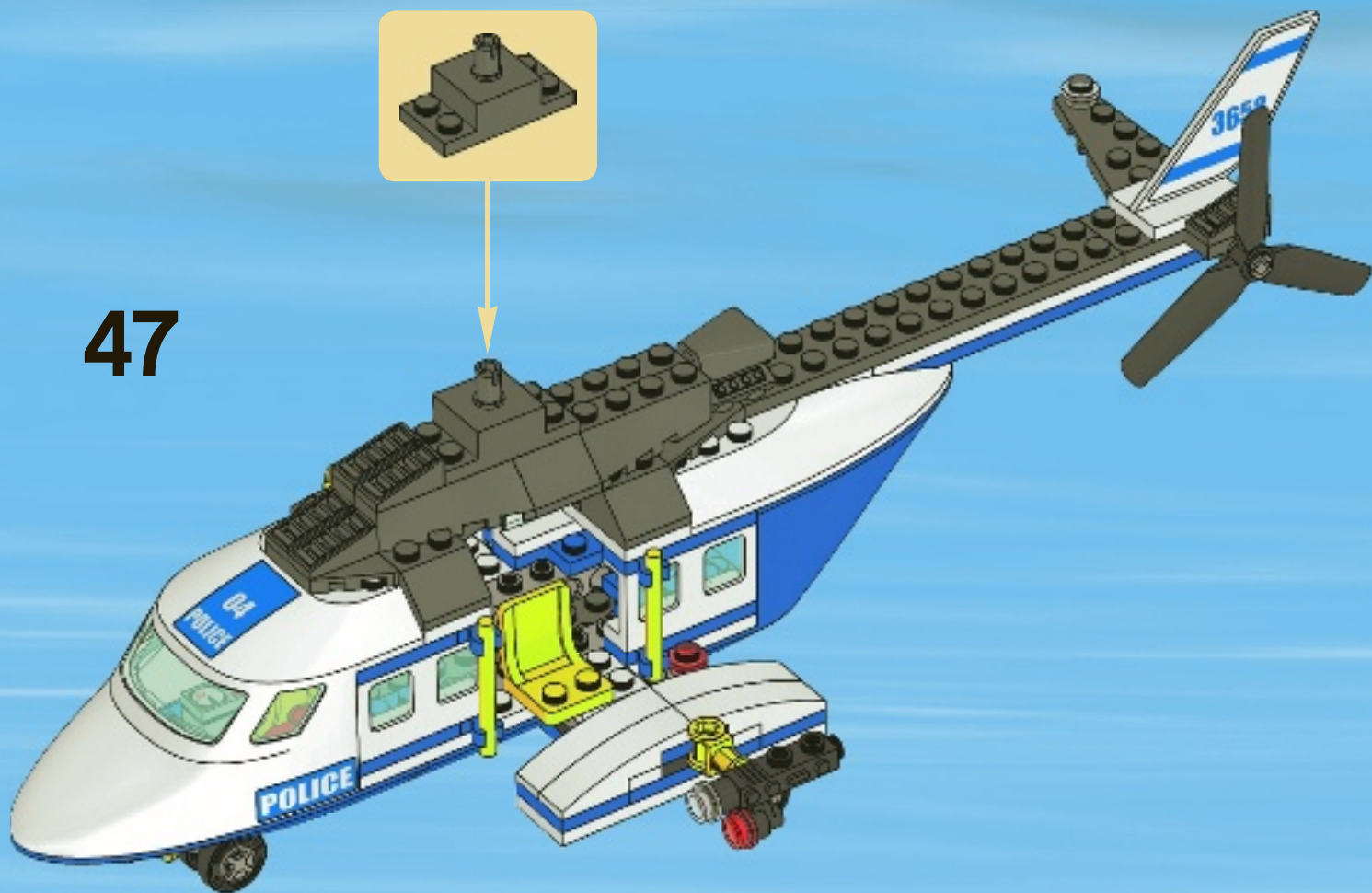

48

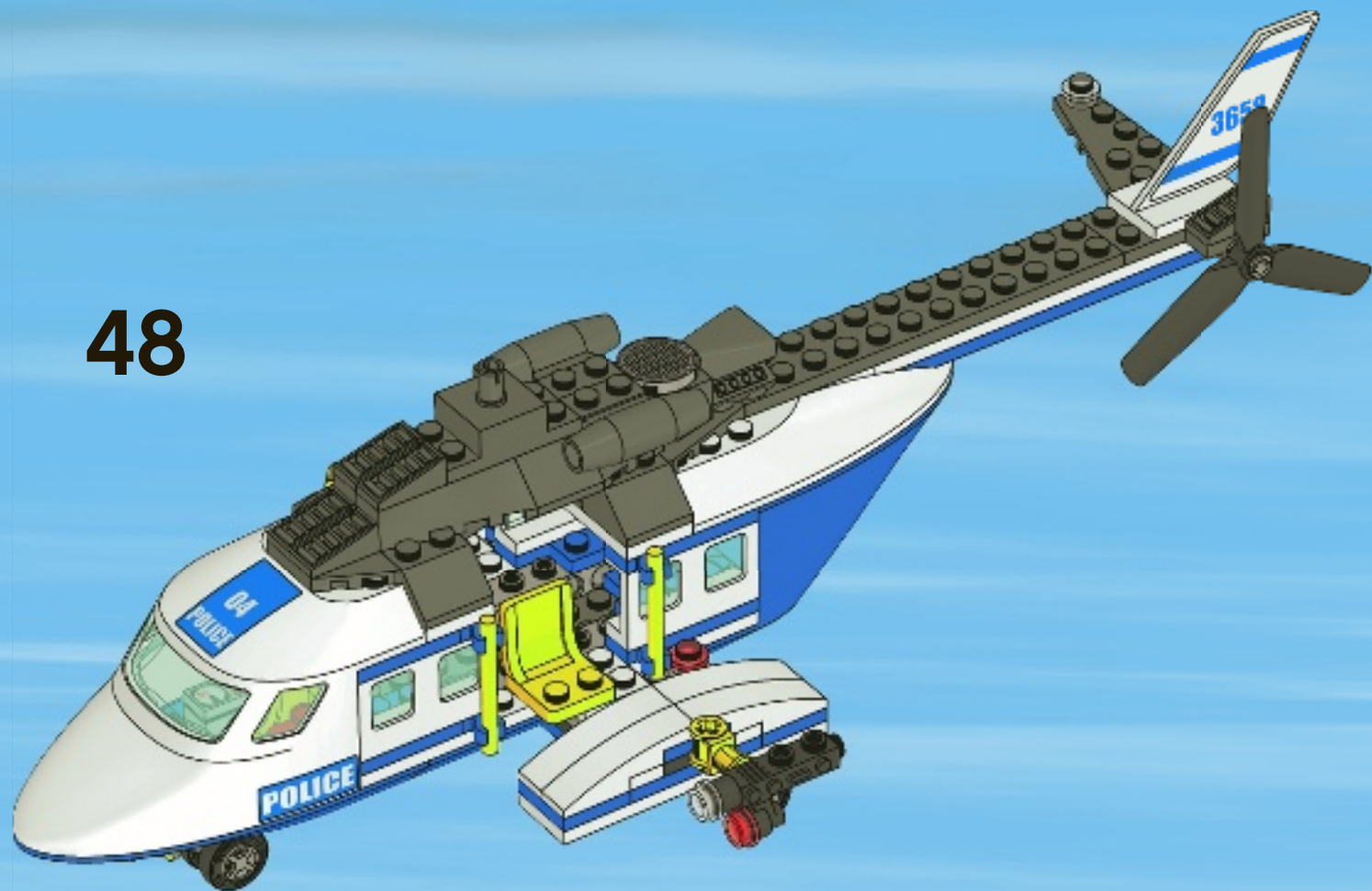

49

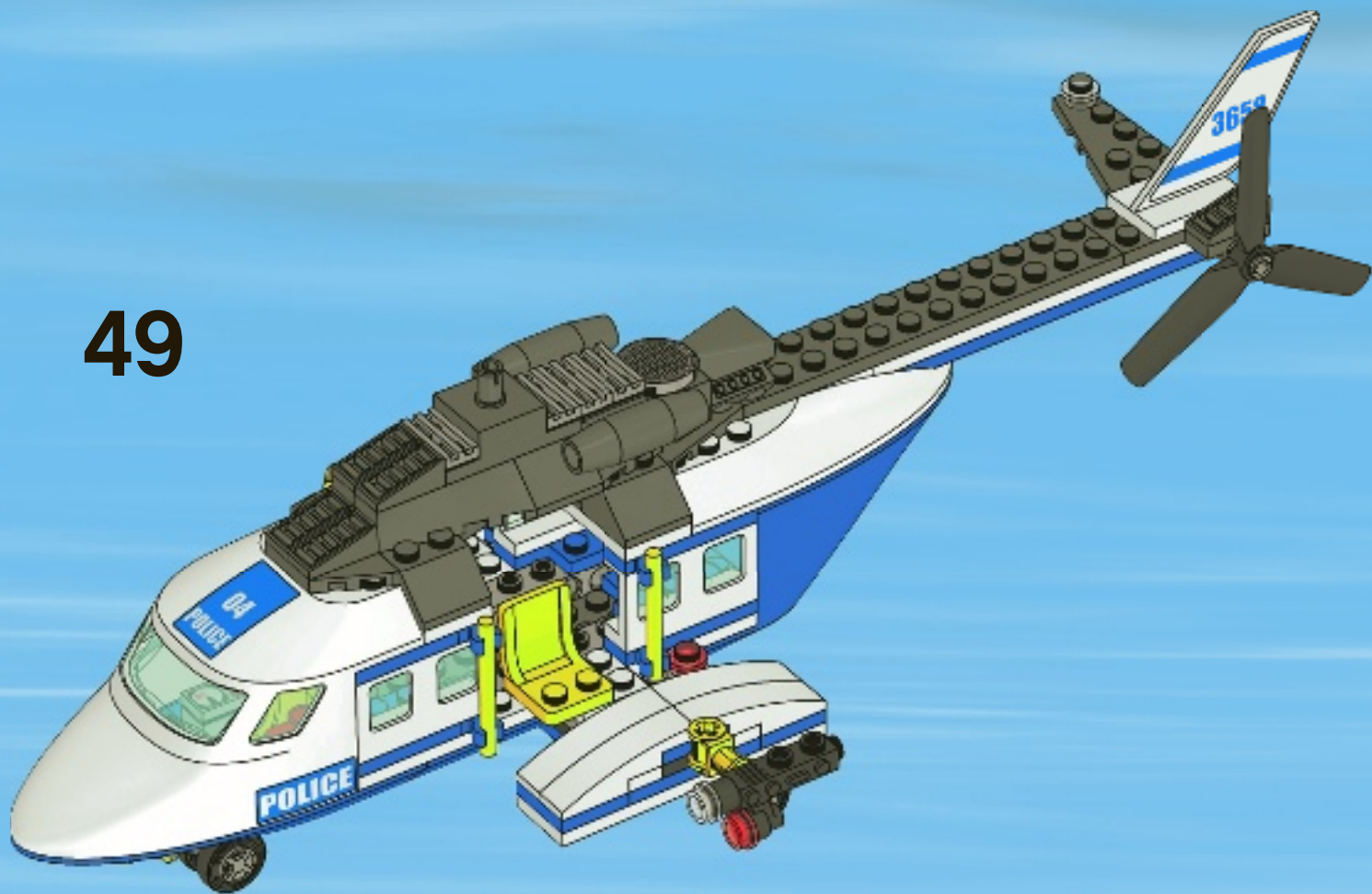



1



2

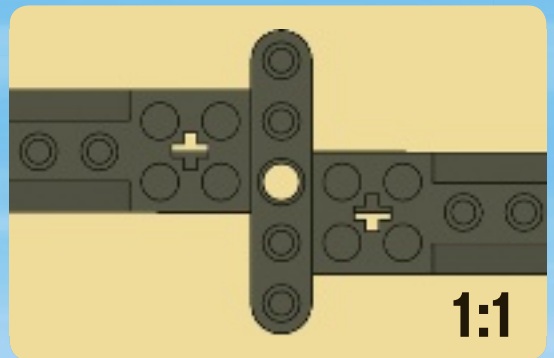
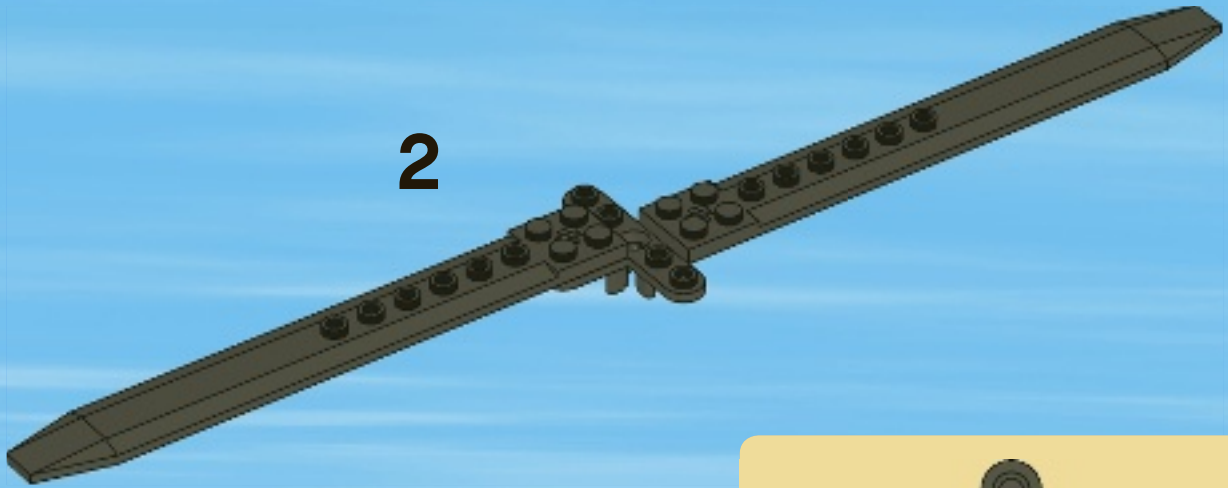



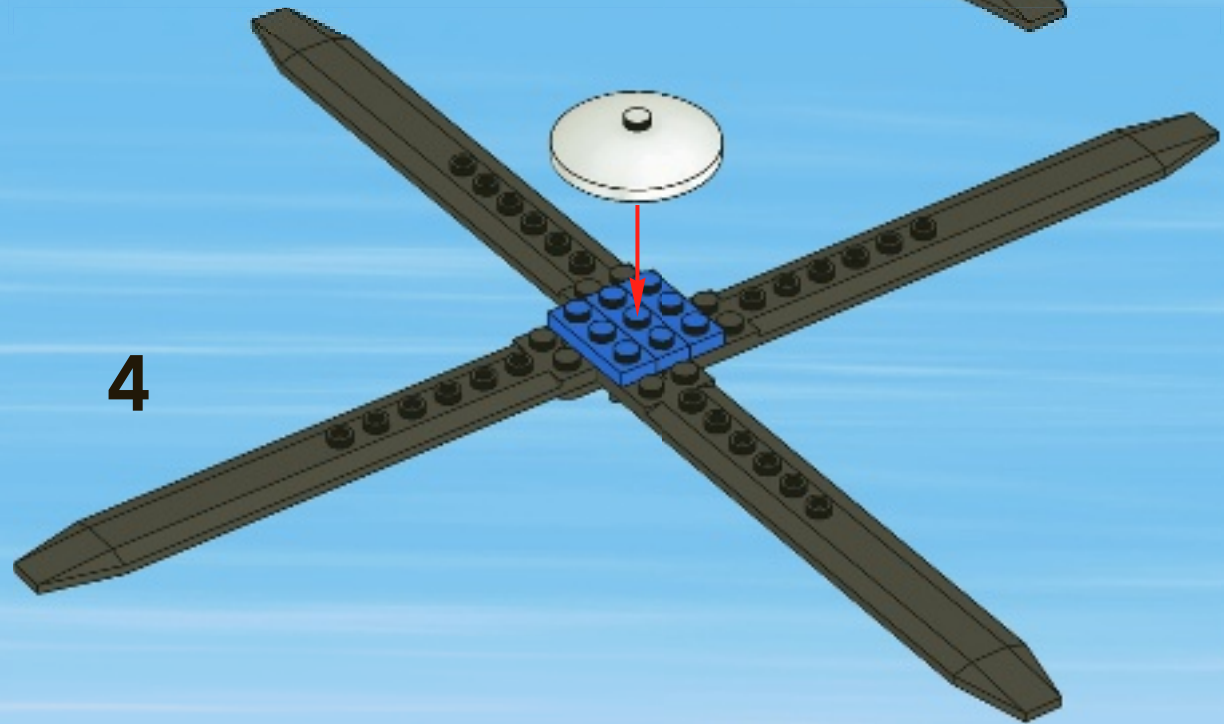
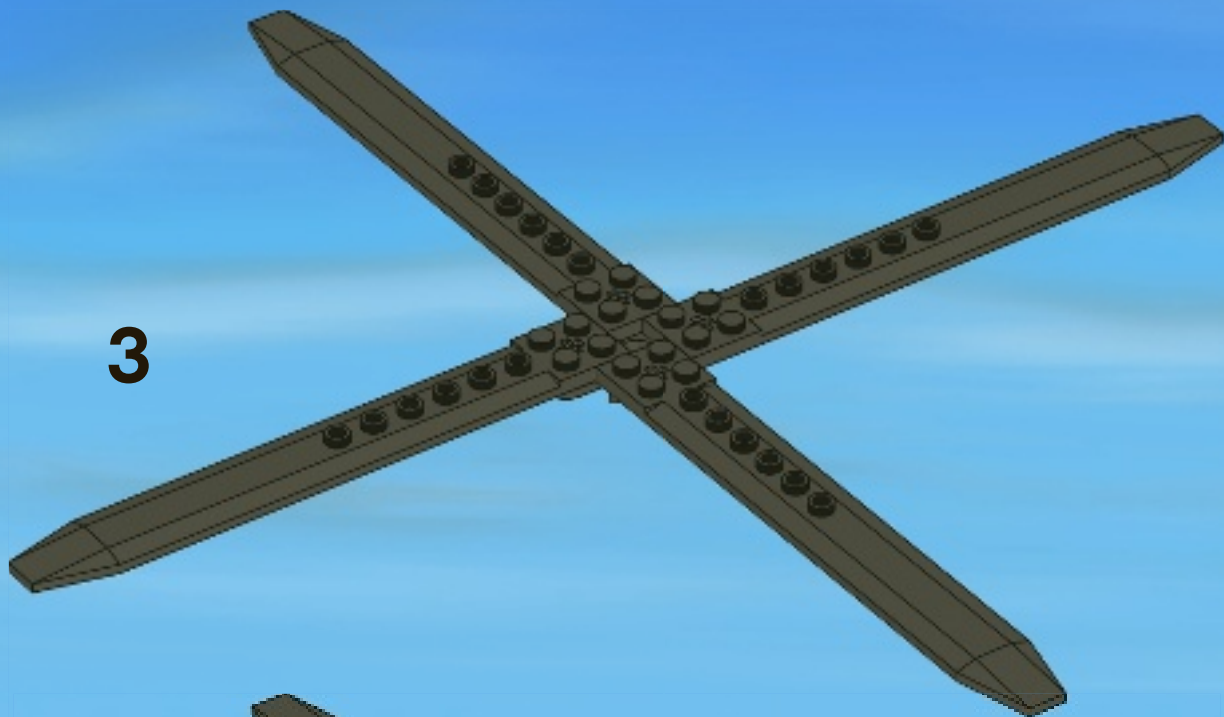



50



51



1



2



52







1x  
4288083



8x  
4518992



9x  
302301



1x  
306901



2x  
379501



3x  
303401



2x  
4514842



1x  
244501



1x  
396001



4x  
4521846



1x  
4275585



1x  
4298609



1x  
362401



1x  
4567912

58



1x  
390001



1x  
623901



1x  
4560934



1x  
4560932



2x  
300421



1x  
407921



1x  
389921



1x  
9552



1x  
4570200



9x  
302223



7x  
362323



5x  
302123



8x  
4613257



1x  
244523



1x  
4528850



1x  
4565421



1x  
4565423



2x  
300524



1x  
301024



1x  
4219911



1x  
302324



3x  
243124



2x  
371024



2x  
407924



4x  
4171666



4x  
4193511



1x  
4259915



1x  
4215503



1x  
4506998



1x  
4506727



1x  
4107800



1x  
4295260



1x  
4227776



2x  
4211395



5x  
4211350



4x  
4211568



2x  
4211516

































2x  
4529120













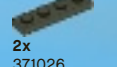
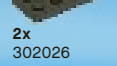
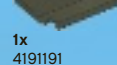
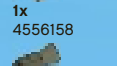
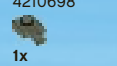
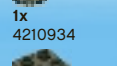









2x  
4211705



 1x 4221881  
 6x 4211506  
 1x 4519013  
 4x 4211758  
 1x 4211807  
 3x 3005740  
 2x 3003941  
 1x 4201019  
 2x 3005741  
 8x 4552034  
 1x 4567994  
 2x 3003944  
 2x 3005744  
 1x 4278415  
 1x 4163306  
 1x 4496442  
 1x 3005743

 1x 3005748  
 1x 4216660  
 3x 9339  
 2x 4598864  
 1x 4275401  
 1x 436026  
 4x 4617848  
 6x 4516843  
 2x 4569733  
 1x 247926  
 1x 4142731  
 4x 4260488  
 4x 4527604  
 1x 4533412

 2x 301026  
 2x 4162443  
 2x 371026  
 2x 302026  
 1x 4191191  
 1x 4556158  
 1x 4210698  
 1x 4579354  
 1x 4210934  
 1x 4196768  
 2x 4211084  
 1x 4239373  
 6x 4211054  
 2x 4298583  
 2x 4298580

 1x 4548100  
 2x 4211067  
 5x 4540386  
 2x 4620760  
 1x 4210635  
 1x 4290149  
 1x 4527082  
 1x 4596895  
 1x 4222693  
 1x 4502068



**Customer Service**  
**Kundenservice**  
**Service Consommateurs**  
**Servicio Al Consumidor**  
[www.lego.com/service](http://www.lego.com/service) or dial  
 : 00800 5346 5555  
 : 1-800-422-5346



# WIN!

Go to [www.LEGOsurvey.com/product](http://www.LEGOsurvey.com/product)  
to fill out a survey for a chance  
to win a cool LEGO® Product.  
No purchase necessary.  
Open to all residents where not prohibited.



## [www.LEGOsurvey.com/product](http://www.LEGOsurvey.com/product)

### GEWINNE! WIN!

Nimm an der Umfrage auf  
[www.LEGOsurvey.com/product](http://www.LEGOsurvey.com/product)  
teil und hab die Chance ein cooles  
LEGO® Produkt zu gewinnen!

Die Teilnahme am Gewinnspiel führt zu keinerlei  
Kaufverpflichtungen. Teilnahme in allen nicht  
ausgeschlossenen Ländern möglich.

Ga naar [www.LEGOsurvey.com/product](http://www.LEGOsurvey.com/product),  
vul een enquêteformulier  
in en maak kans op een  
cool LEGO® product.

Geen aankoopverplichting.  
Iedereen mag deelnemen, uitgezonderd  
ingezetenden van landen waar een  
enquêteverbod geldt.

### GAGNE! 当てよう!

Visite [www.LEGOsurvey.com/product](http://www.LEGOsurvey.com/product)  
pour répondre à un  
questionnaire et avoir une chance de  
gagner un produit LEGO® très cool!

Aucune obligation d'achat.  
Ouvert à tous les résidents des pays  
autorisés.

[www.LEGOsurvey.com/product](http://www.LEGOsurvey.com/product) にアクセスして、  
アンケートにご記入ください。当選者にはレゴ®  
製品を差し上げます。

お買い上げの必要はありません。

禁止されていない限り、すべての皆様にご利用いただけます。