



CREATOR

10241



EXPERT

Maersk Line



Maersk Line is the container shipping division of A.P. Moller – Maersk. Operating more than 600 container ships and 4,100,000 twenty-foot container units, Maersk Line is the world's leading container shipping company.

Visit www.maerskline.com for more information on our services.

Die Maersk Line ist die Abteilung bei A.P. Moller – Maersk, die für den Containertransport zuständig ist. Sie betreibt mehr als 600 Containerschiffe und 4.100.000 „20-Fuß-Container“ und ist somit das weltgrößte Container-Transportunternehmen.

Weitere Informationen stehen unter www.maerskline.com zur Verfügung.

Maersk Line est la division de transport de conteneurs d'A.P. Moller – Maersk. Avec plus de 600 porte-conteneurs et 4 100 000 conteneurs de 20 pieds (6 mètres), Maersk Line est le plus grand armateur de porte-conteneurs du monde.

Visitez www.maerskline.com pour obtenir plus d'informations sur nos services.

Maersk Line es la división de transporte de contenedores de A.P. Moller – Maersk. Con más de 600 buques de contenedores y 4.100.000 contenedores de veinte pies, Maersk Line es la empresa de transporte de contenedores más importante del mundo.

Visita el sitio web www.maerskline.com si deseas obtener más información acerca de nuestros servicios.

Maersk Line é a divisão de transporte marítimo da A.P. Moller – Maersk. Moller – Maersk. A operar mais de 600 navios de transporte de contentores e 4.100,000 TEU (contentores de vinte pés), a Maersk Line é a maior empresa a nível mundial de transporte de contentores.

Visite www.maerskline.com para mais informações sobre os nossos serviços.

A Maersk Line az A.P. Moller – Maersk konténerszállító részlege. Több mint 600 konténerszállító hajót és 4 100 000 húszlábás konténert üzemeltetve, a Maersk Line a világ vezető konténerszállító vállalata.

Szolgáltatásainkról bővebben tájékozódhat a www.maerskline.com honlapon.

The Container – Le Conteneur

The container is a vital tool in today's global world. In containers, raw materials and manufactured goods can be transported around the world, at sea, by truck and on rail wagons.

The typical container is either a 20 foot container or a 40 foot container. It can be a dry container or a refrigerated container or a special container, like a flat-rack container.

The container and low-cost, reliable shipping in combination with efficient container terminals and the vast infrastructures of motorways and railroads make up the most important transport system in the world. Maersk Line provides its customers with the world's most reliable services.

Der Container ist aus der heutigen globalisierten Welt nicht mehr wegzudenken. Mithilfe von Containern können Rohstoffe und hergestellte Waren weltweit über den Seeweg, die Straße oder per Bahn transportiert werden.

Der typische Container ist entweder ein so genannter „20-Fuß-Container“ mit ca. 6 Metern Länge oder ein „40-Fuß-Container“ mit etwas über 12 Metern Länge. Neben Trockencontainern und Kühlcontainern gibt es auch spezielle Container wie zum Beispiel den Flachcontainer.

Der Container und der kostengünstige Transport bilden in Verbindung mit leistungsstarken Container-Terminals und einer riesigen Infrastruktur aus Bahn- und Straßennetz eines der wichtigsten Transportsysteme der Welt. Die Maersk Line bietet ihren Kunden einen der weltweit zuverlässigsten Dienste.

Le conteneur est un outil vital dans le monde globalisé d'aujourd'hui. Grâce aux conteneurs, les matières premières et les produits finis peuvent être transportés dans le monde entier par bateau, par camion et sur des wagons de train.

Le conteneur typique mesure soit 20 pieds (6 mètres), soit 40 pieds (12 mètres). Il peut être sec, réfrigéré ou spécial, par exemple un conteneur plateforme.

Les conteneurs et un transport maritime fiable à faible coût, combinés avec des terminaux pour conteneurs efficaces et de vastes infrastructures d'autoroutes et de voies ferrées composent le système de transport le plus important au monde. Maersk Line fournit à ses clients les services les plus fiables au monde.

El contenedor es una herramienta fundamental para el mundo globalizado actual. Los contenedores permiten transportar materias primas y artículos manufacturados a todas partes del mundo, en barco, en camión y en ferrocarril.

Un contenedor típico mide 20 o 40 pies. Puede ser un contenedor seco, refrigerado o especial, como los de plataforma.

Al representar un medio de transporte barato y seguro, y contar con eficaces terminales de contenedores y vastas redes de carretera y ferrocarril, el contenedor es el sistema de transporte más importante del mundo. Maersk Line presta a sus clientes los servicios más seguros del mundo.

O contentor é uma ferramenta vital no mundo globalizado de hoje. Graças aos contentores, matérias primas e bens manufaturados podem ser transportados para toda a parte do mundo, por mar, camião e por caminhos de ferro.

Entende-se por **contentor normal**, um contentor com 20 pés ou 40 pés. Pode ser um contentor seco, refrigerado ou especial, tal como um contentor de caixa aberta.

O contentor e o transporte de confiança barato, combinados com os terminais eficientes para contentores e a vasta infraestrutura de autoestradas e caminhos de ferro tornam-no o mais importante sistema de transporte do mundo. A Maersk Line oferece aos seus clientes os serviços de maior confiança a nível mundial.

A konténer létfontosságú szerepet tölt be napjaink globalizált világában. Konténerekben lehet szállítani világszerte a nyersanyagokat, a készárakat tengeren, kamionokon és vasúti kocsikon.

A tipikus konténer lehet 20 lábás vagy 40 lábás konténer. Ez lehet száraz konténer vagy hűtött konténer, esetleg speciális konténer, mint például a nyitott konténer.

A konténer és az alacsony költségű, megbízható szállítás a hatékony konténer terminálokkal és az autóutak és vasutak óriási infrastruktúrájával a világ legfontosabb szállítási rendszerét alkotja. A Maersk Line a világ legmegbízhatóbb szolgáltatásai nyújtja felhasználóinak.



CHALLENGE:
Build a LEGO® model interpretation of the world's largest ship

HERAUSFORDERUNG:
Ein LEGO® Modell bauen, das vom größten Schiff der Welt inspiriert ist

DÉFI :
Construis un modèle LEGO® du plus grand bateau du monde

ACEPTA EL DESAFÍO:
Construye el barco más grande del mundo al estilo LEGO®

DESAFIO:
Constrói o modelo LEGO® que é a interpretação do maior barco do mundo

KIHÍVÁS:
Építsd meg a világ legnagyobb hajójának LEGO® modelljét



Designer building the model
Der Designer bei der Arbeit
Designer construisant le modèle
El diseñador construye el modelo
Designer a construir o modelo
Tervező a modell építése közben



Authenticity down to placing a good-luck coin under the mast

Authentizität bis ins letzte Detail: die Münze am Mast

L'authenticité va jusqu'à placer une pièce porte-bonheur sous le mât

Máximo realismo: coloca una moneda de la buena suerte bajo el mástil

Autêntico ao ponto de ter uma moeda de boa sorte sob o mastro

Hitelesség, egészen az árboc alatti szerencse érme elhelyezéséig.

Approval by the license partner
A.P. Moller-Maersk

Freigabe durch den Lizenzpartner
A.P. Moller-Maersk

Approbation par le partenaire de licence,
A.P. Moller-Maersk

Aprobado por el propietario de la licencia:
A.P. Moller-Maersk

Aprovação pelo parceiro detentor da licença, a A.P. Moller-Maersk

Jóváhagyás licencpartnerünk, az A.P. Moller-Maersk által.



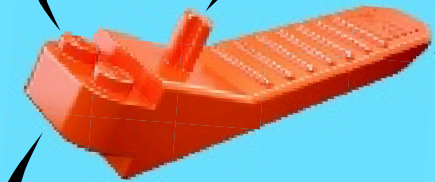
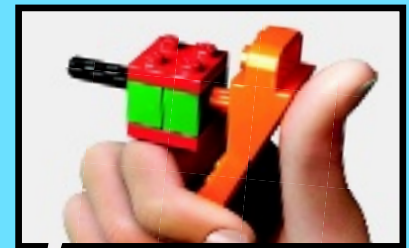

LEGO.com/
brickseparator

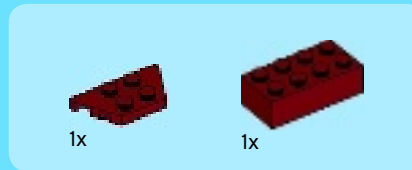

1

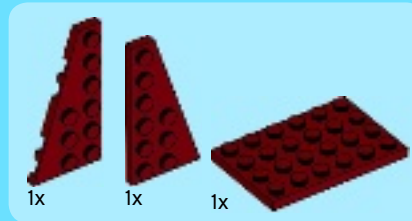
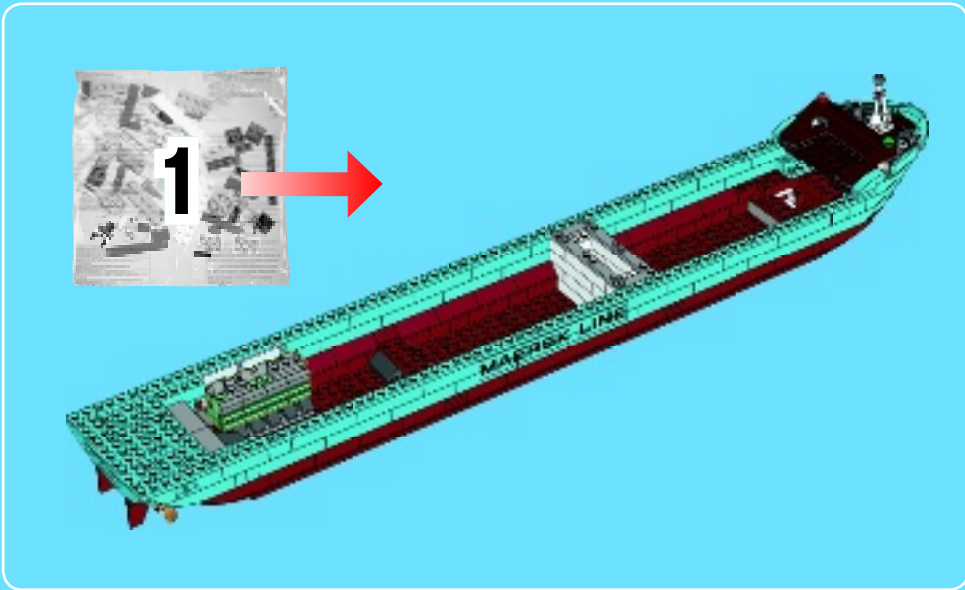

2

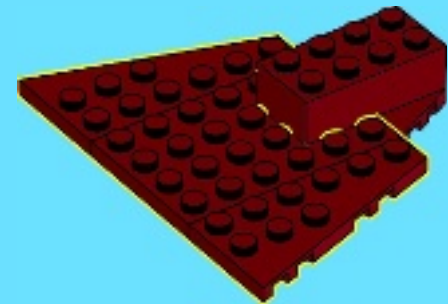



2x



2x

3

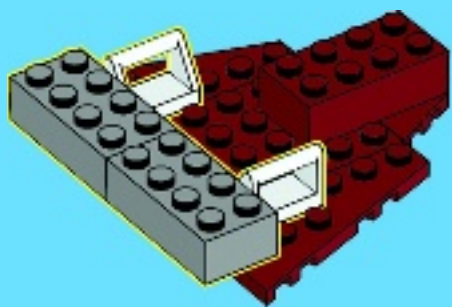

6x

5

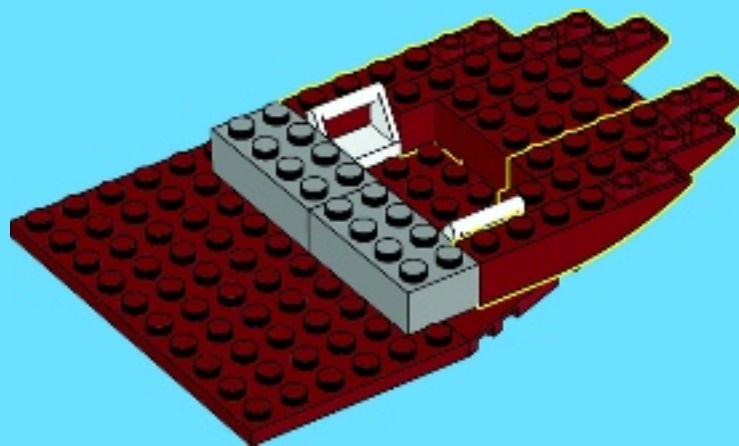

1x

4

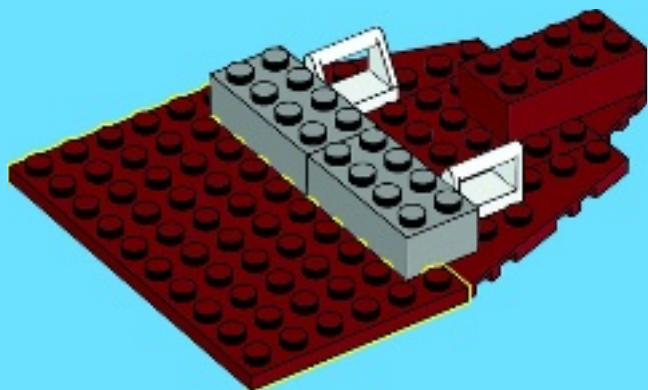

6x



1x



1x

6



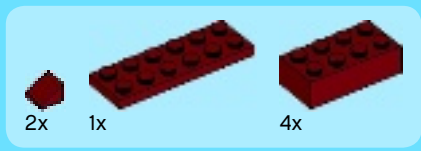

7

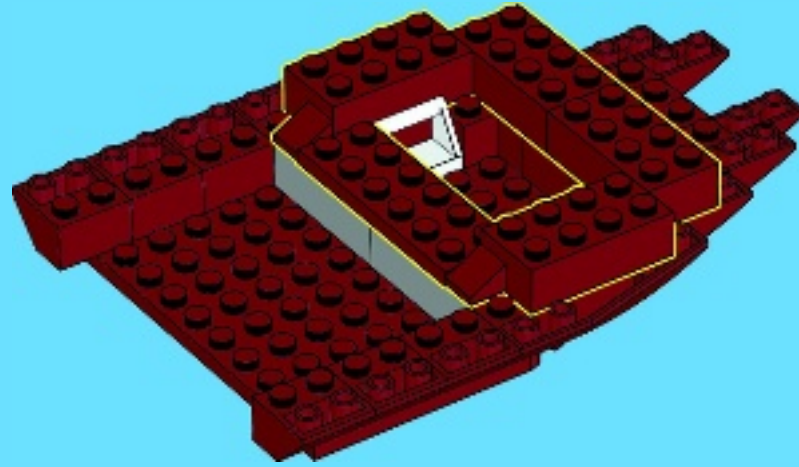

8

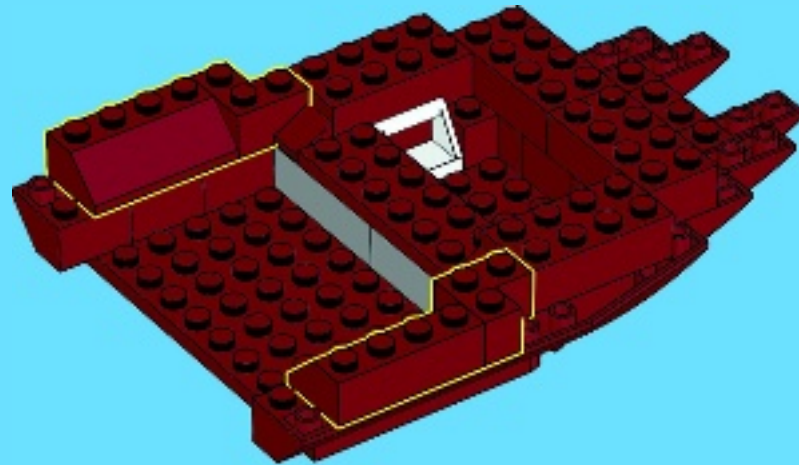

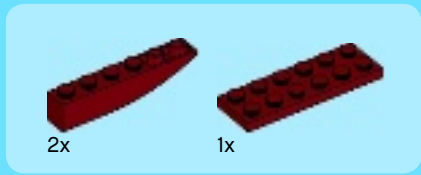

9

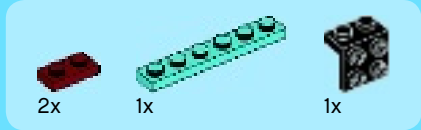
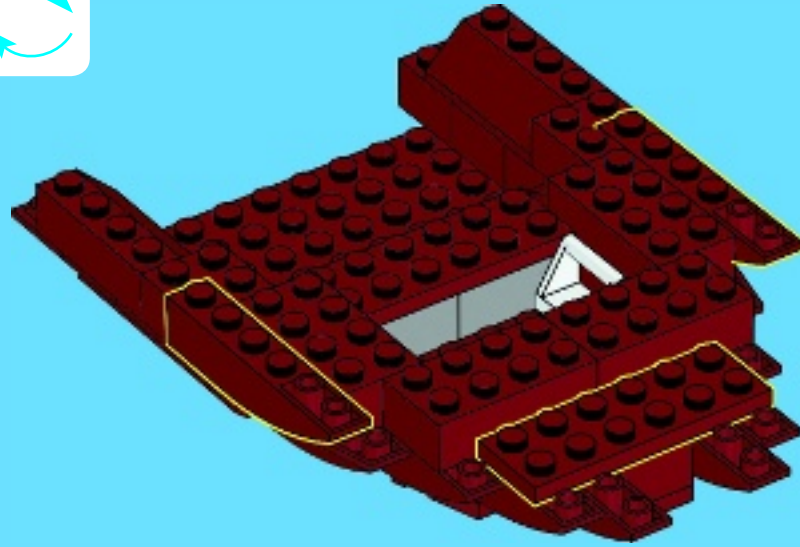

10

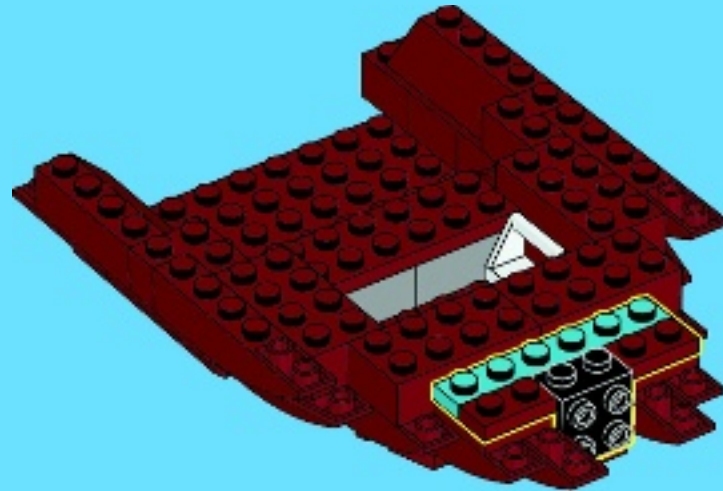

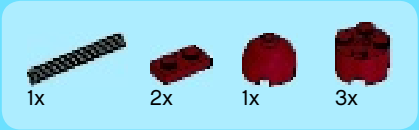

11

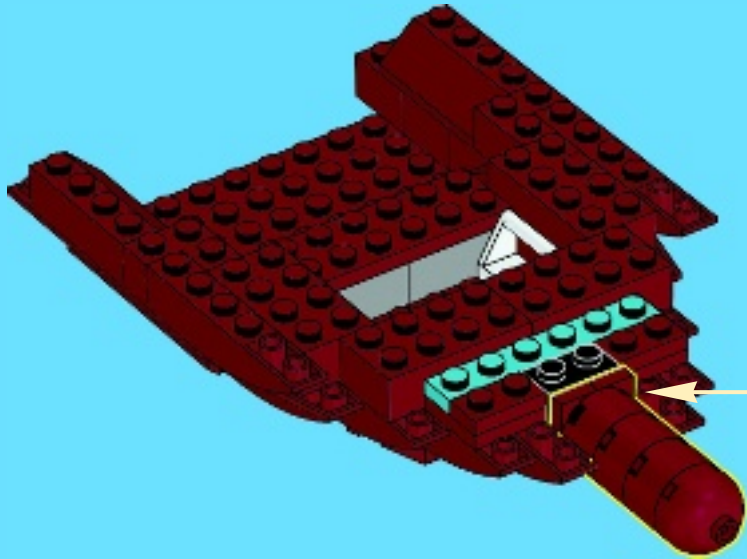
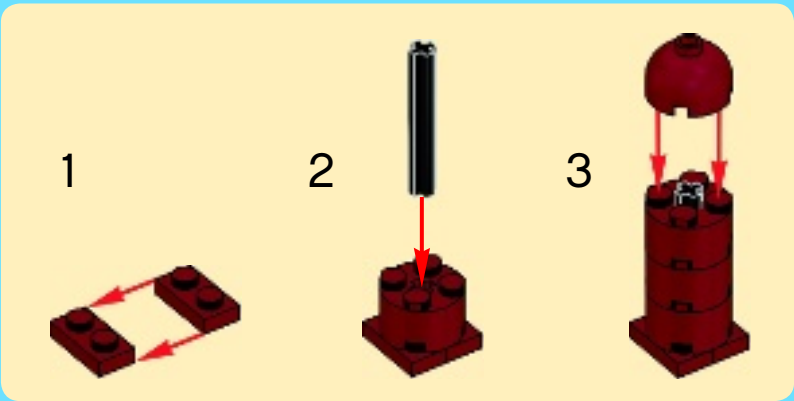

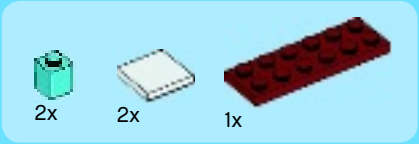

12

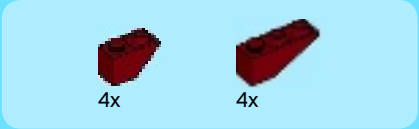
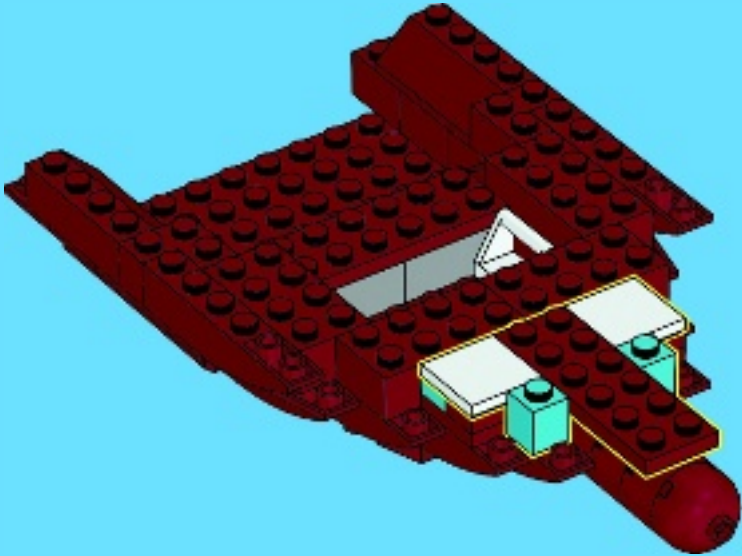

13

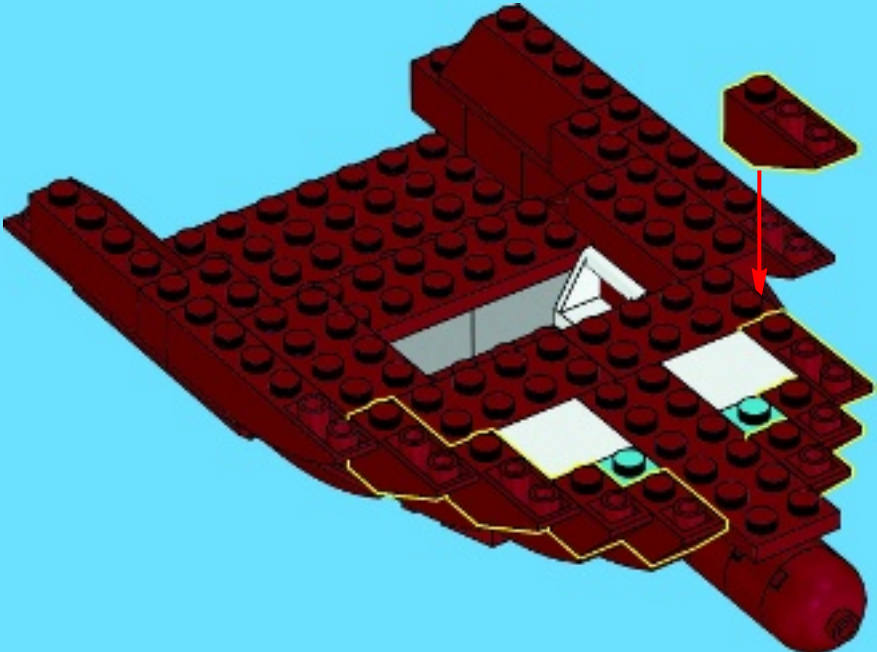



14

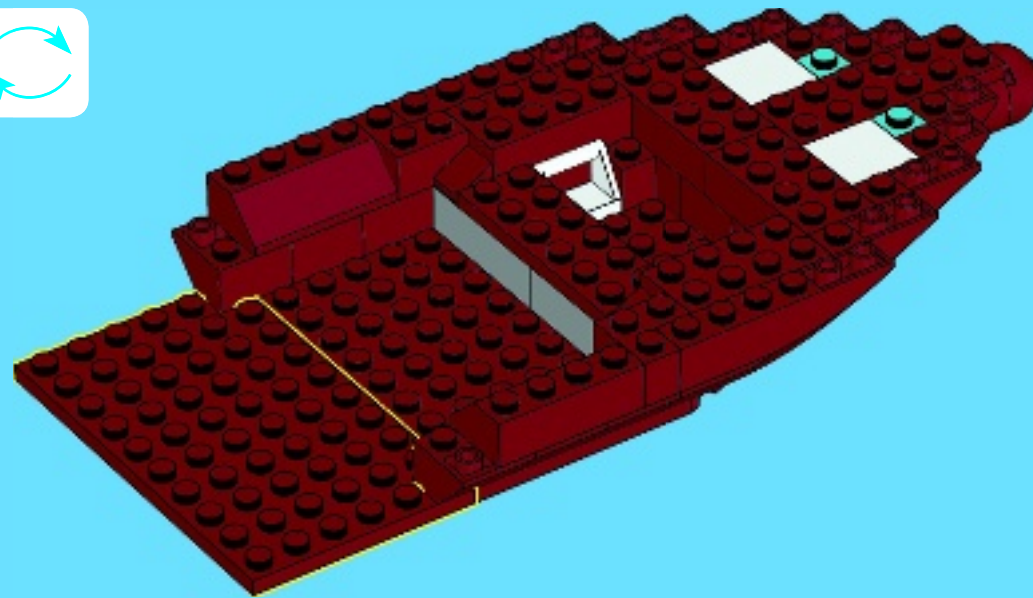

15

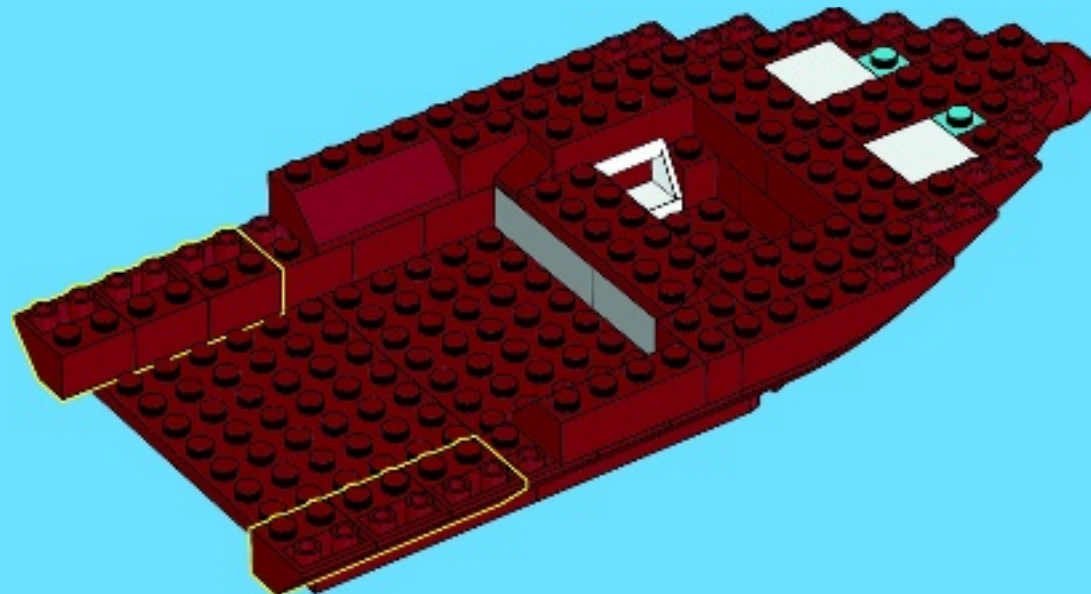

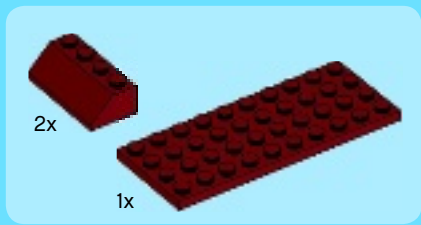

16

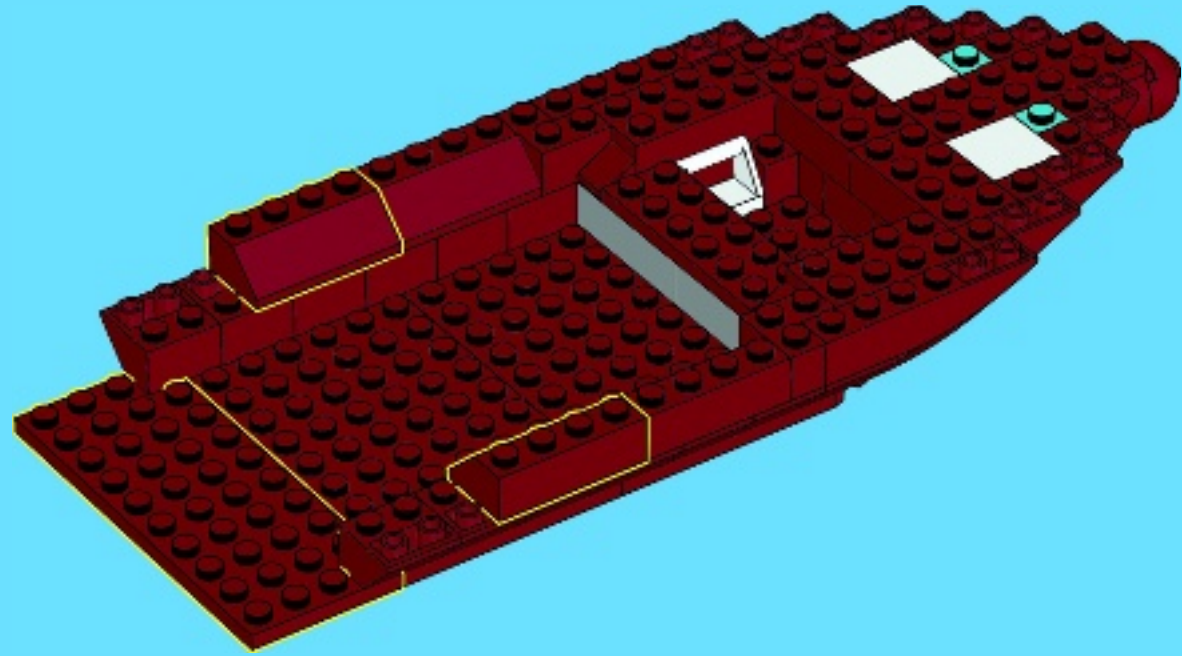

17

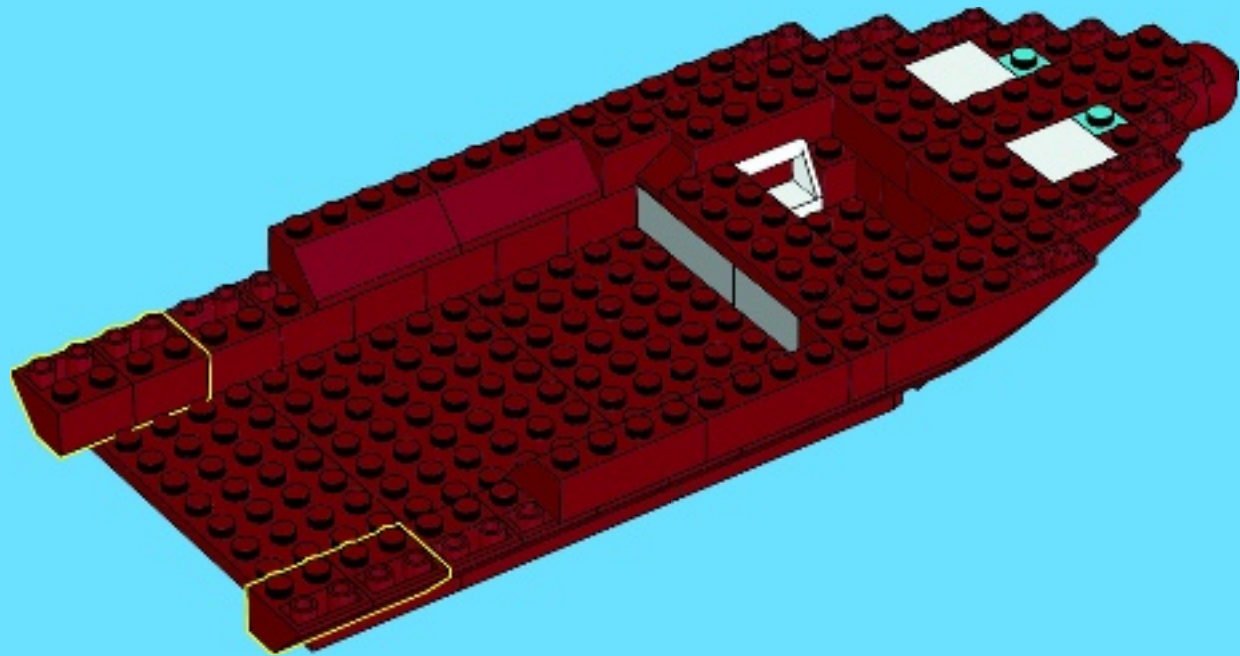



18

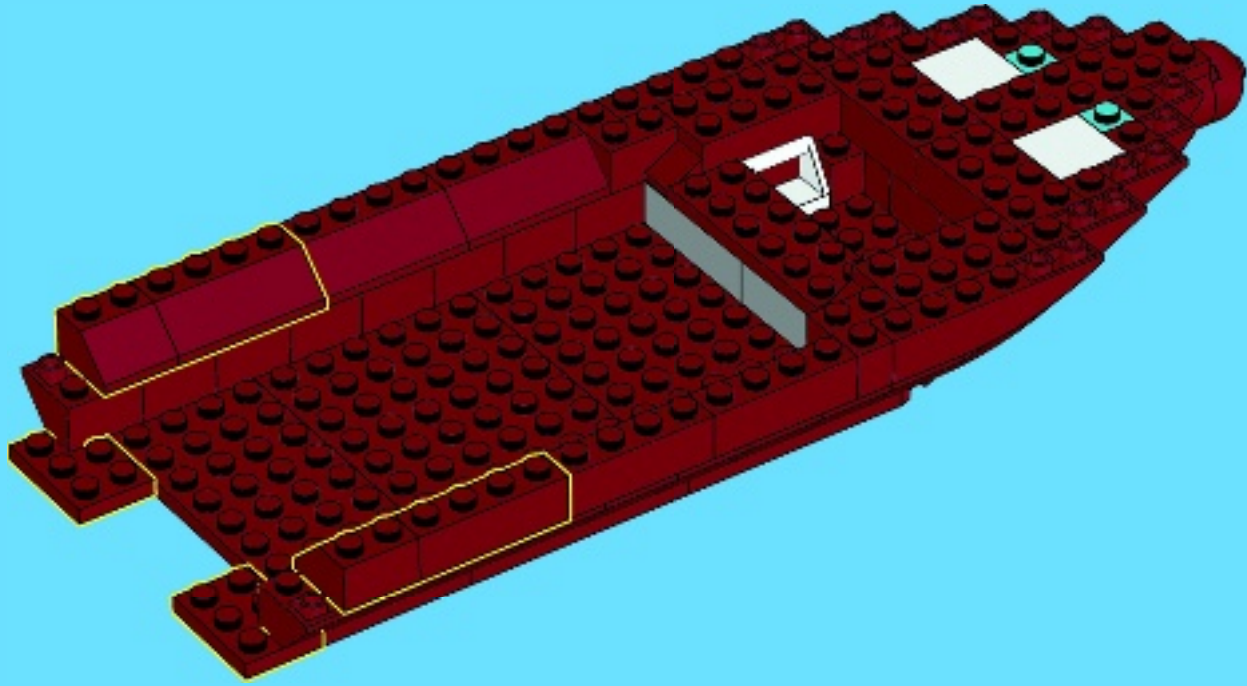

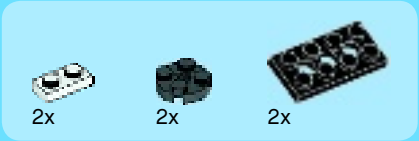

19

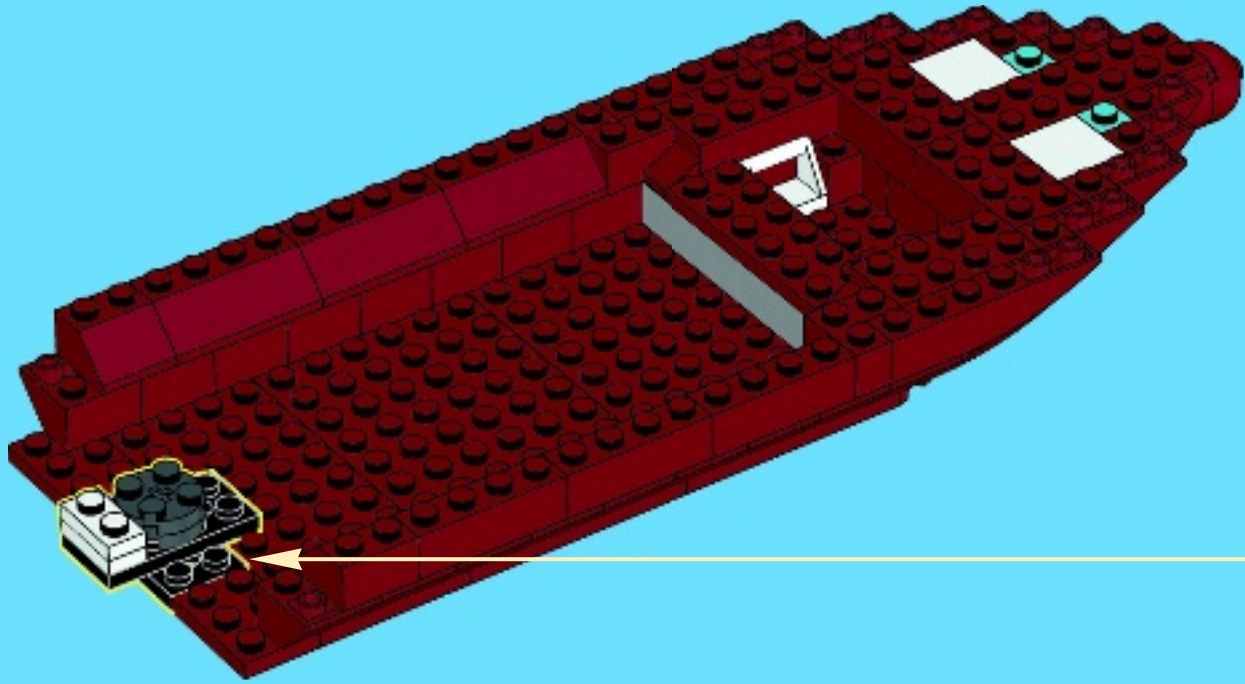
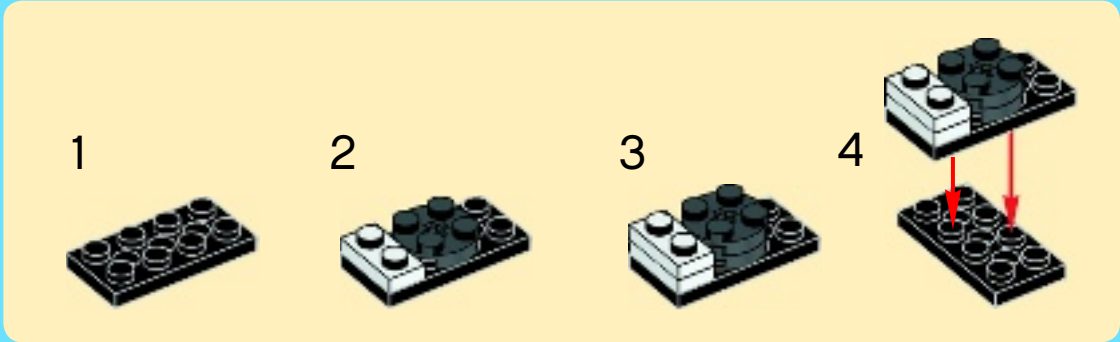



2x



2x

20

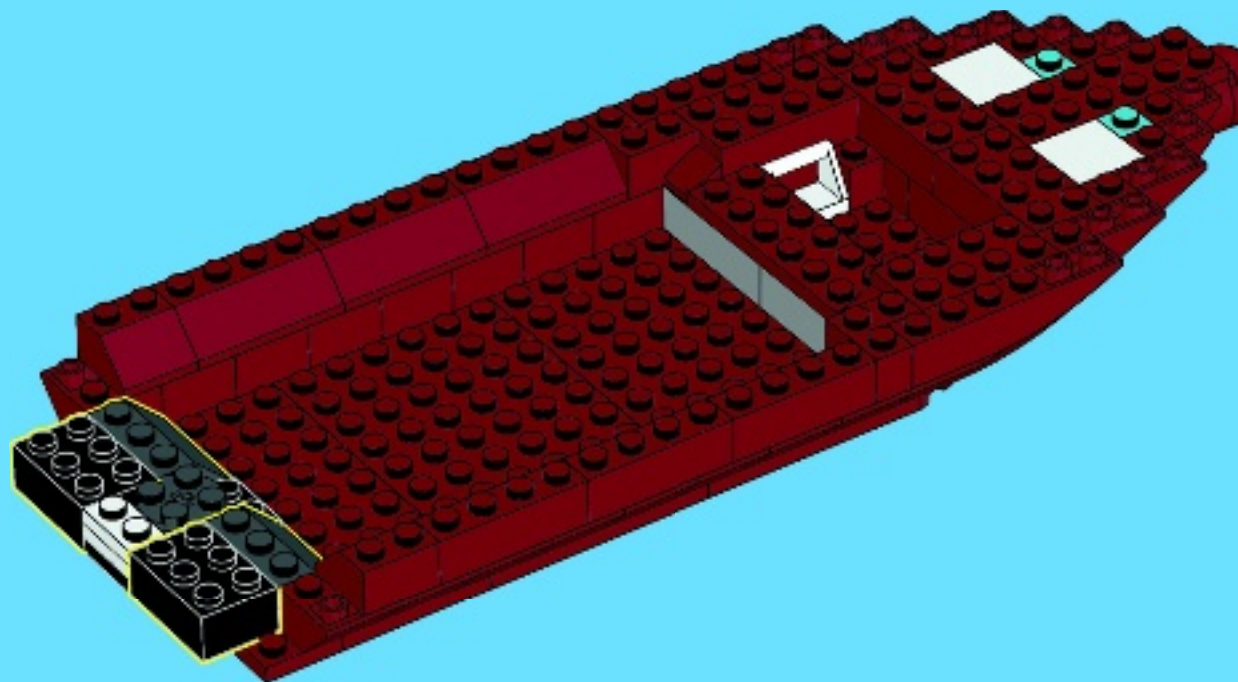



21

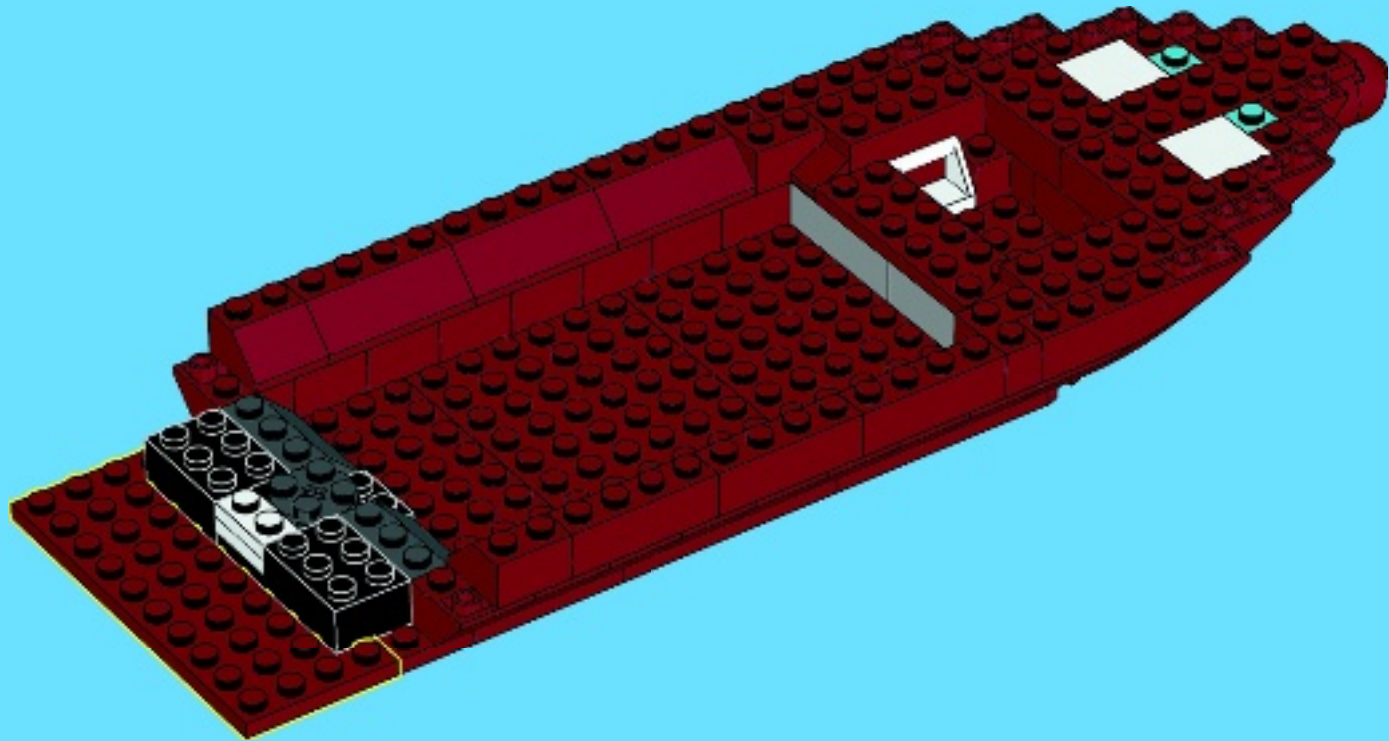



6x

22

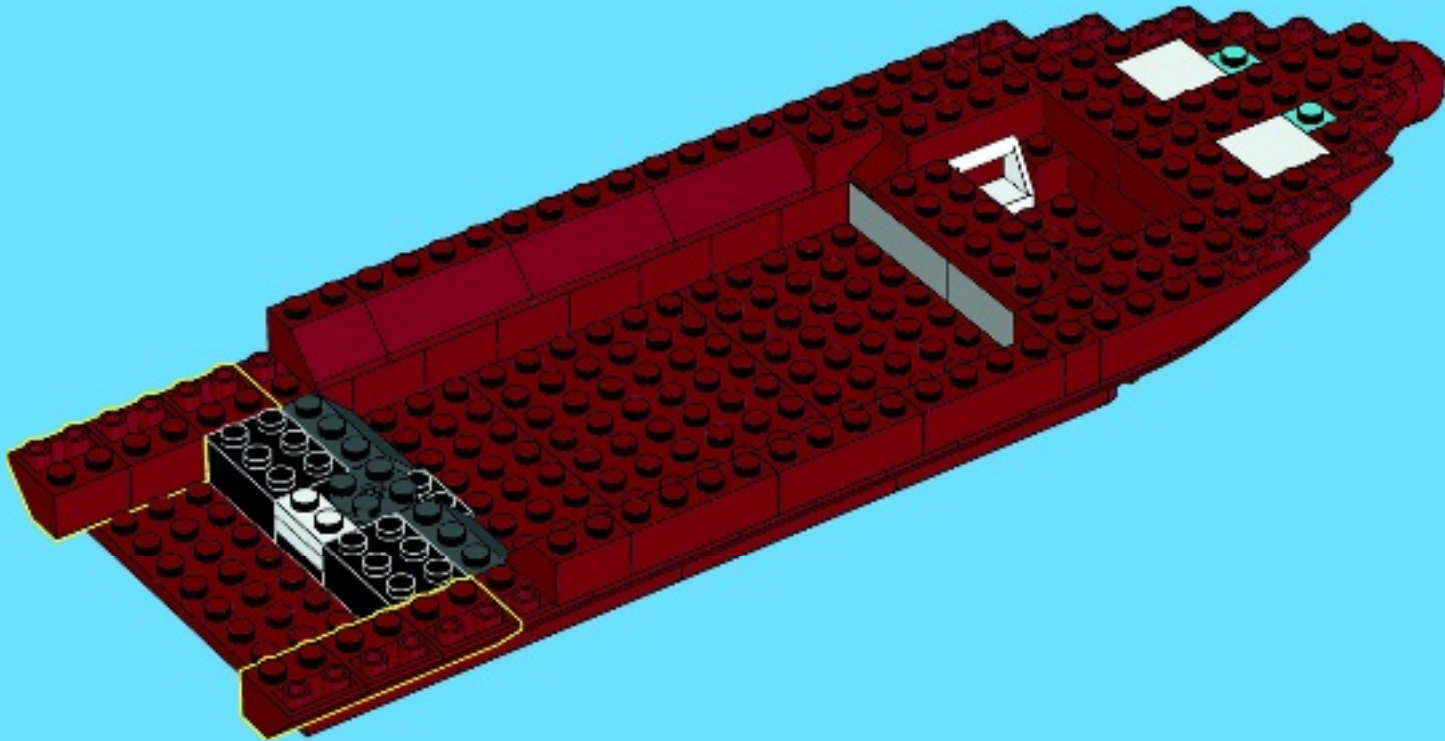

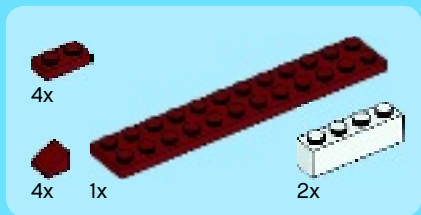

23

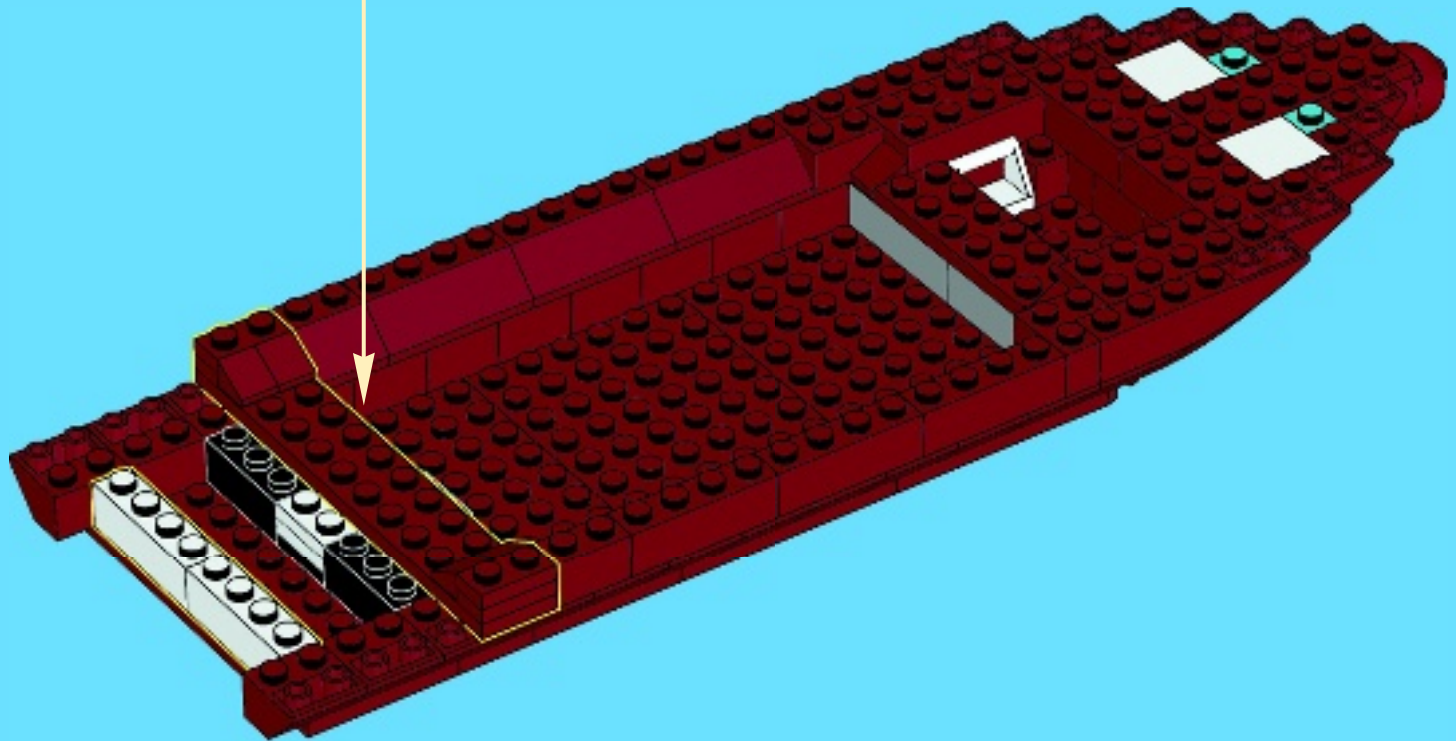
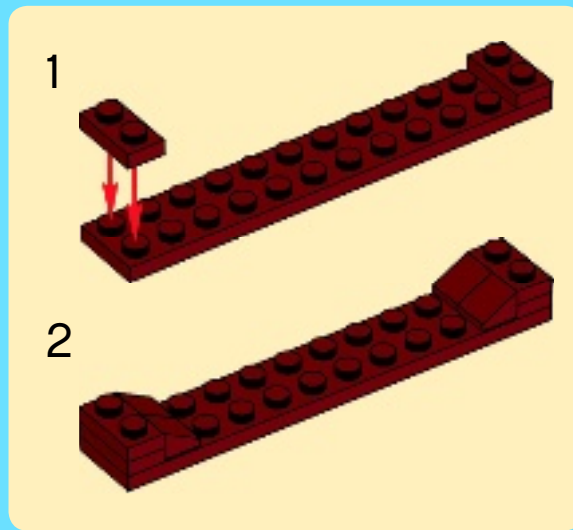



24

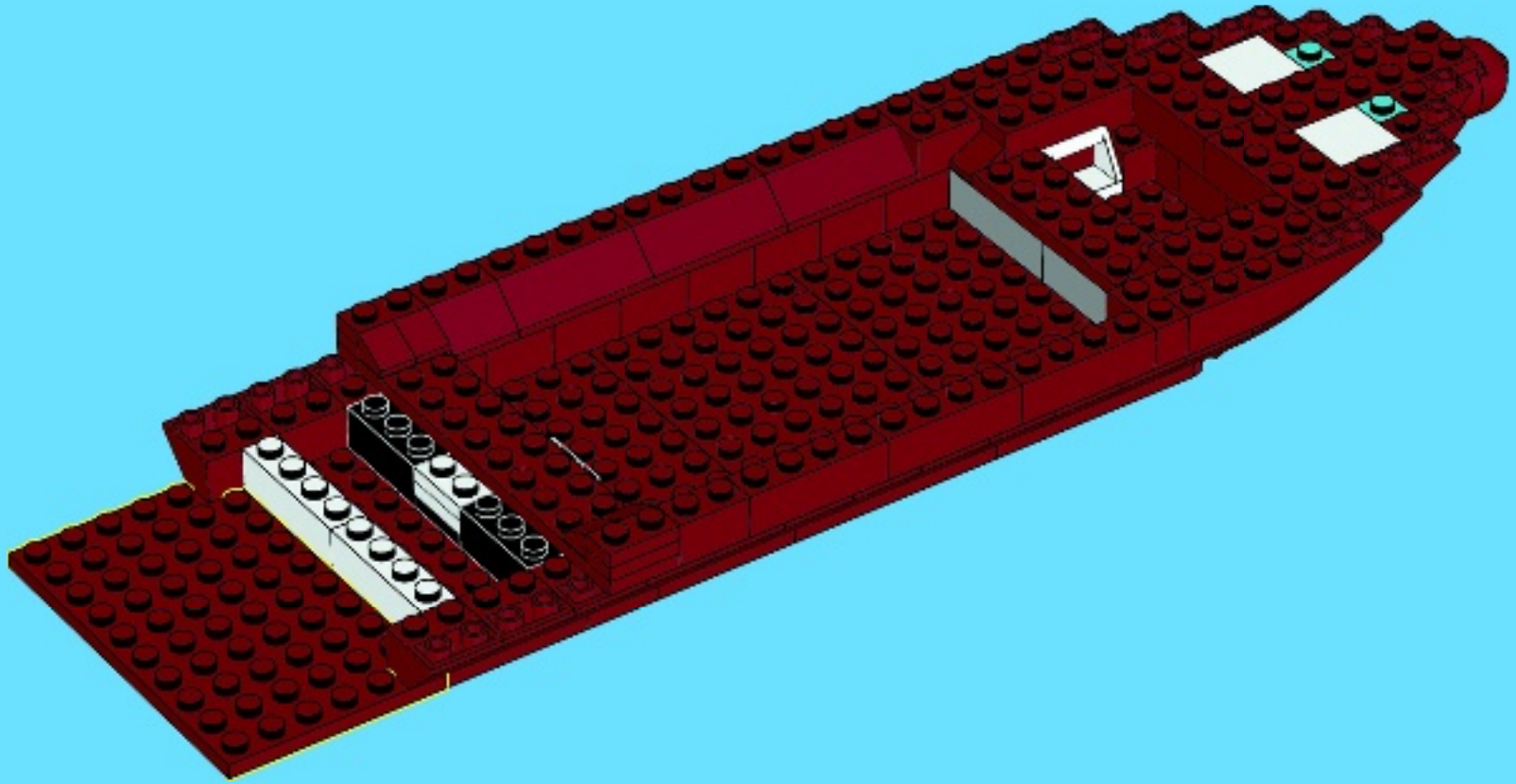

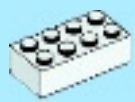

2x



2x

25

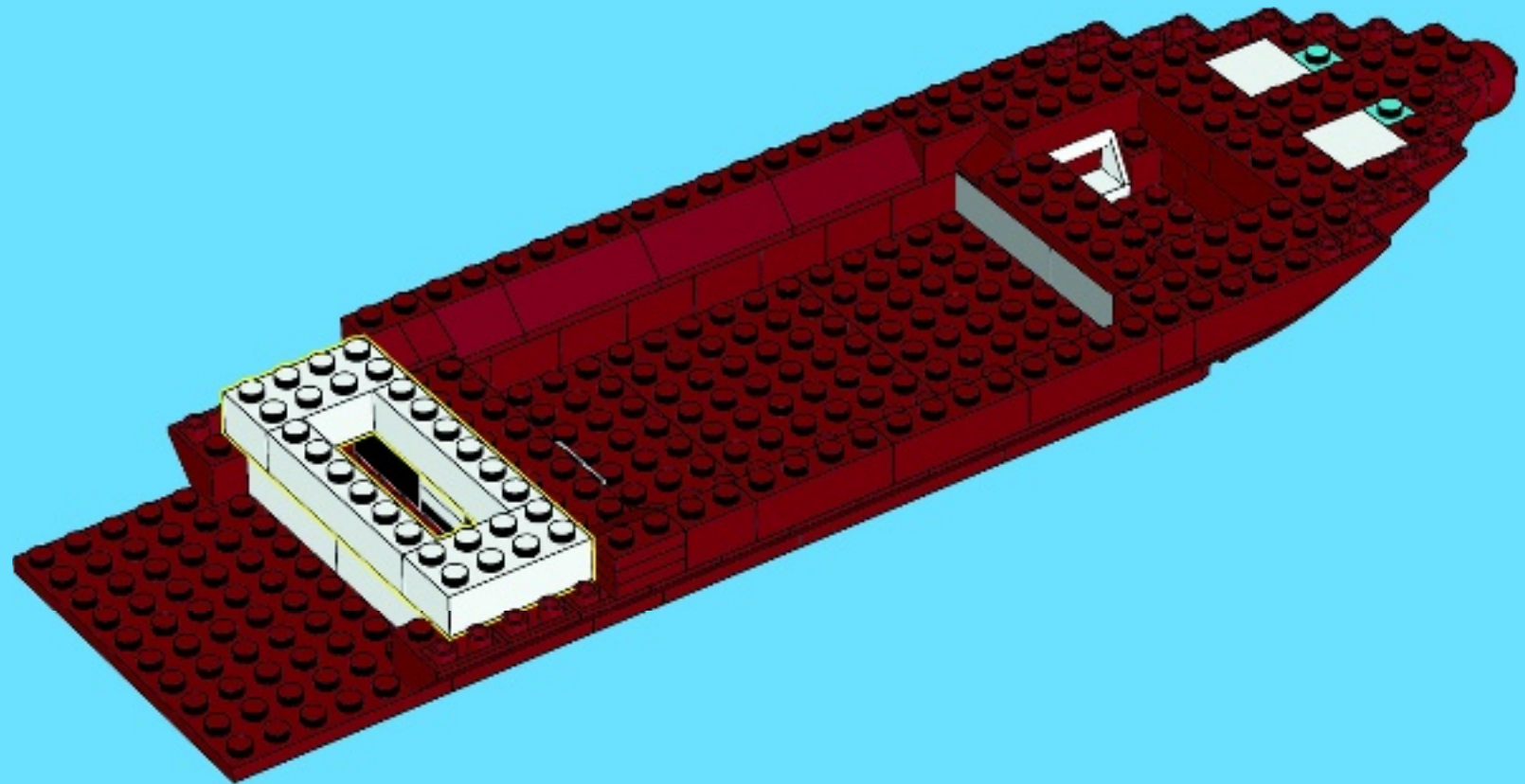



2x



6x

26

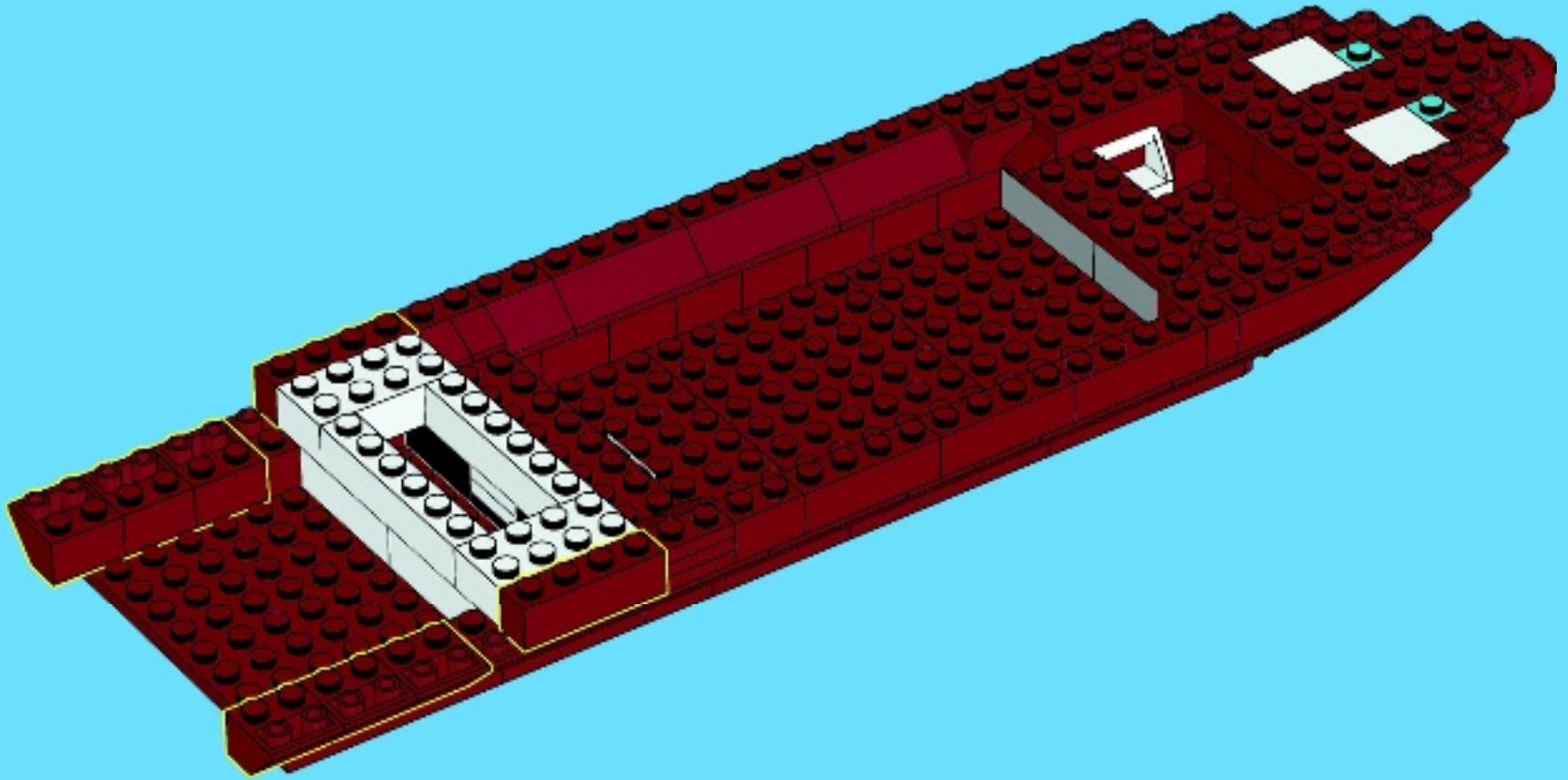



27

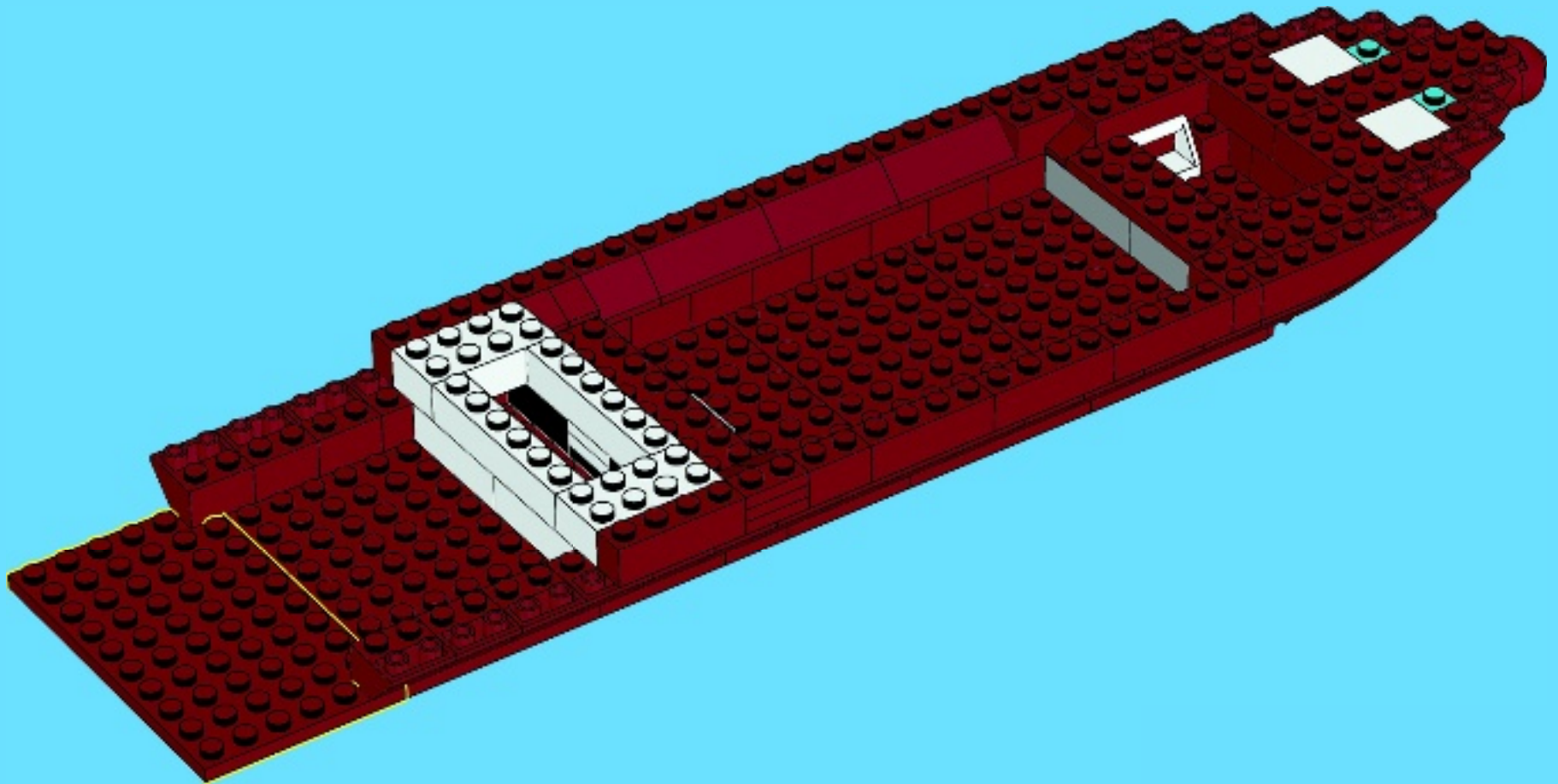



6x

28

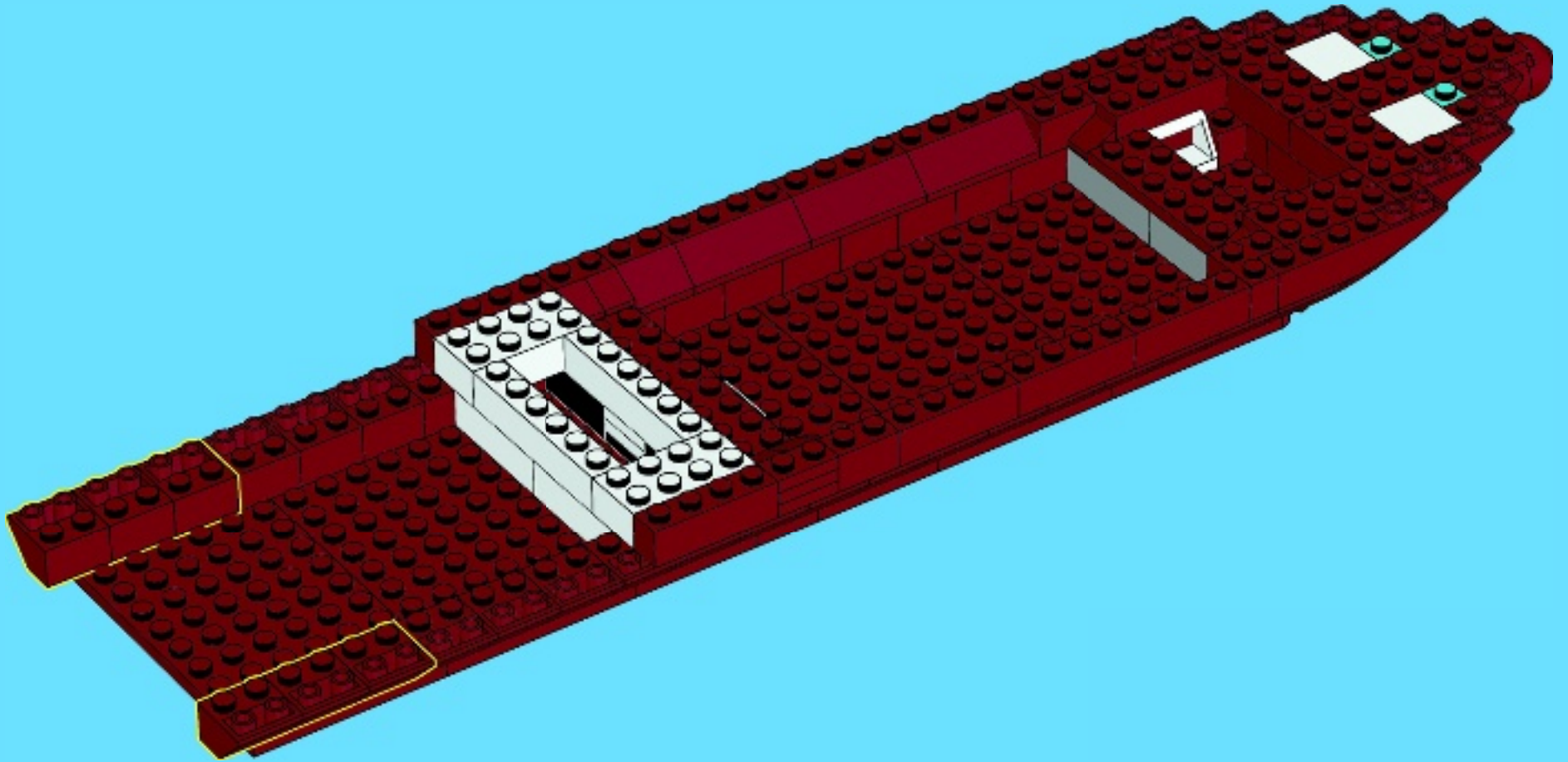

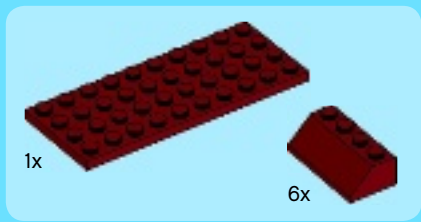

29

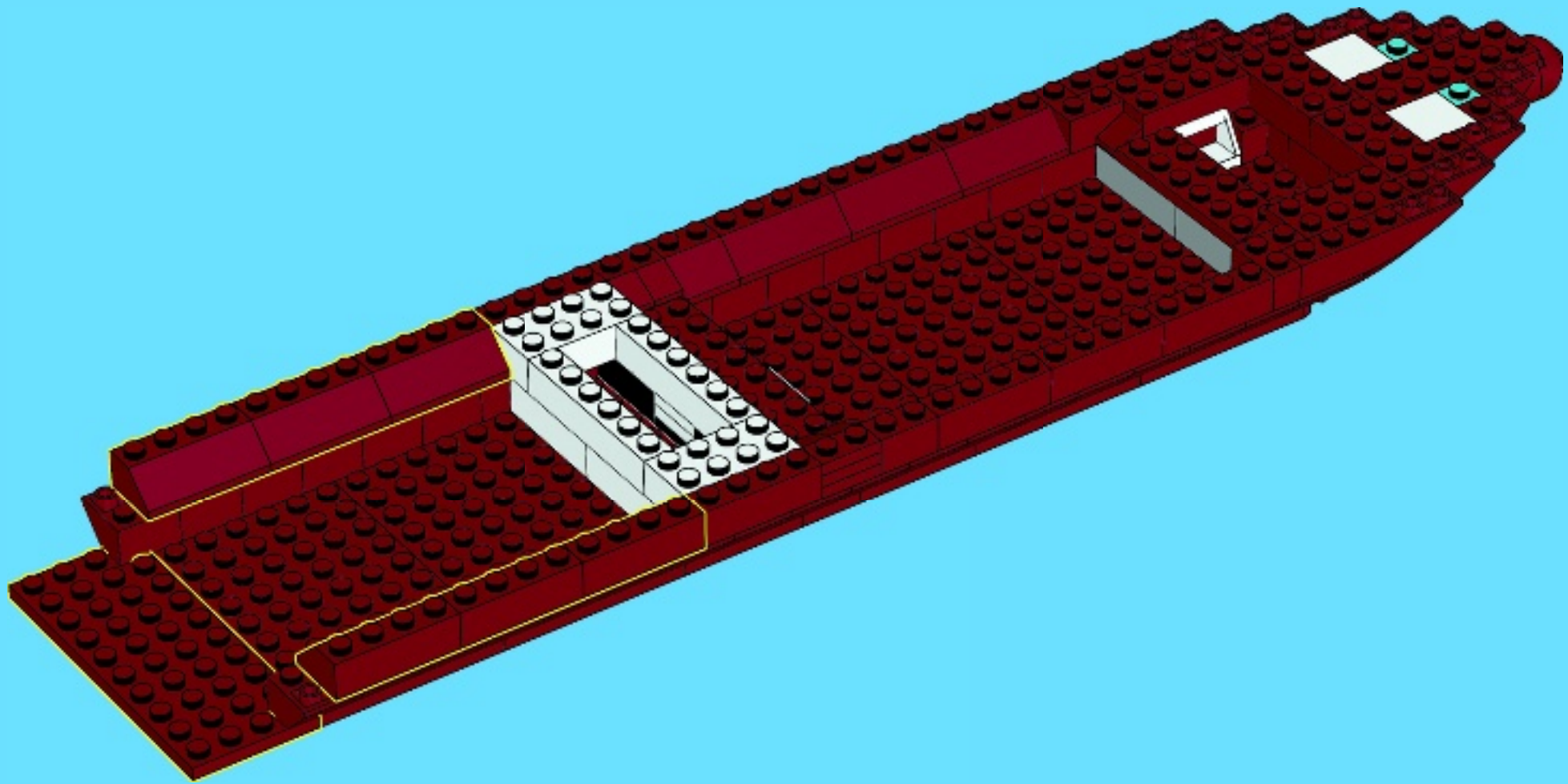



4x

30

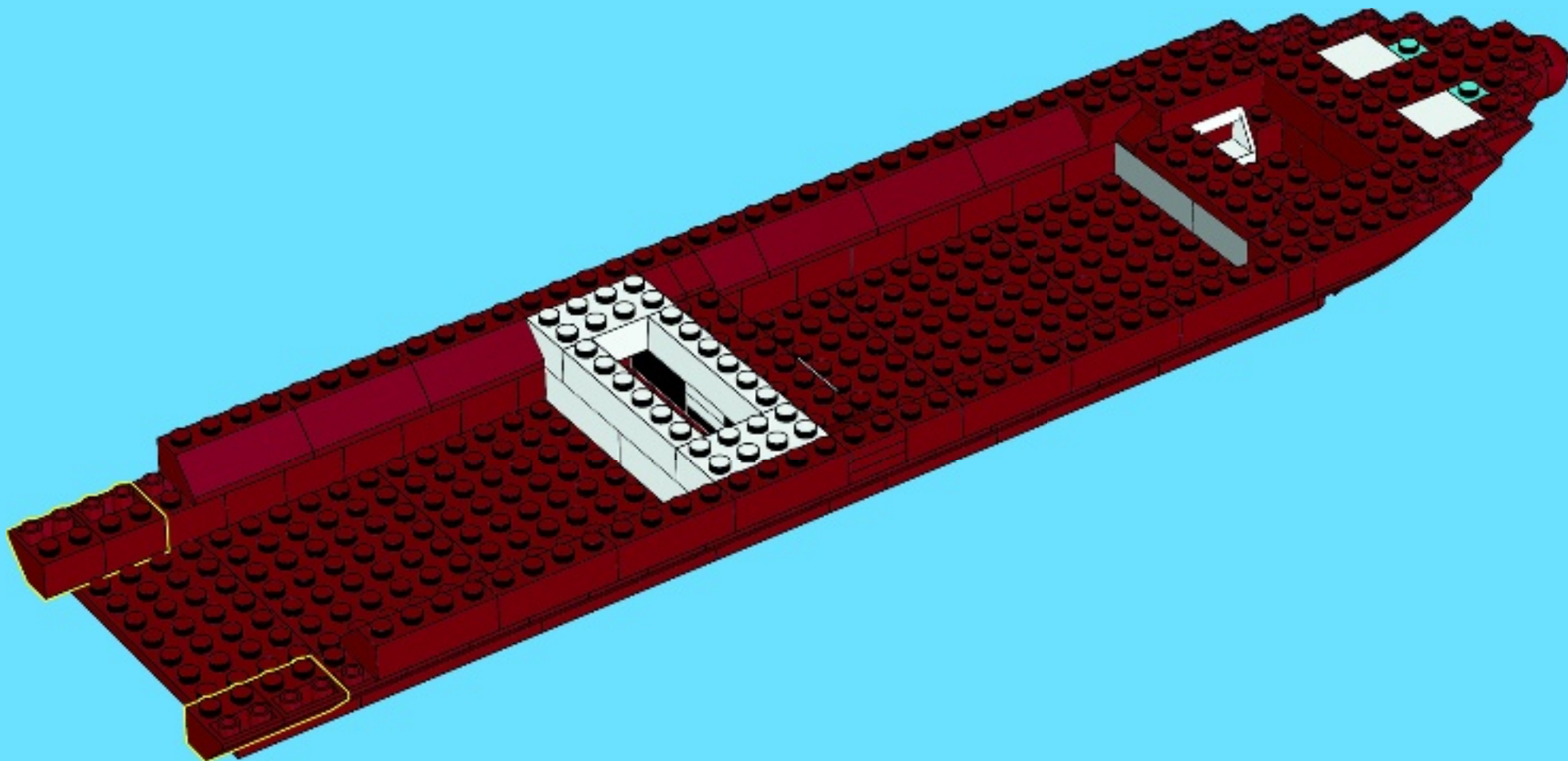



2x



2x

31

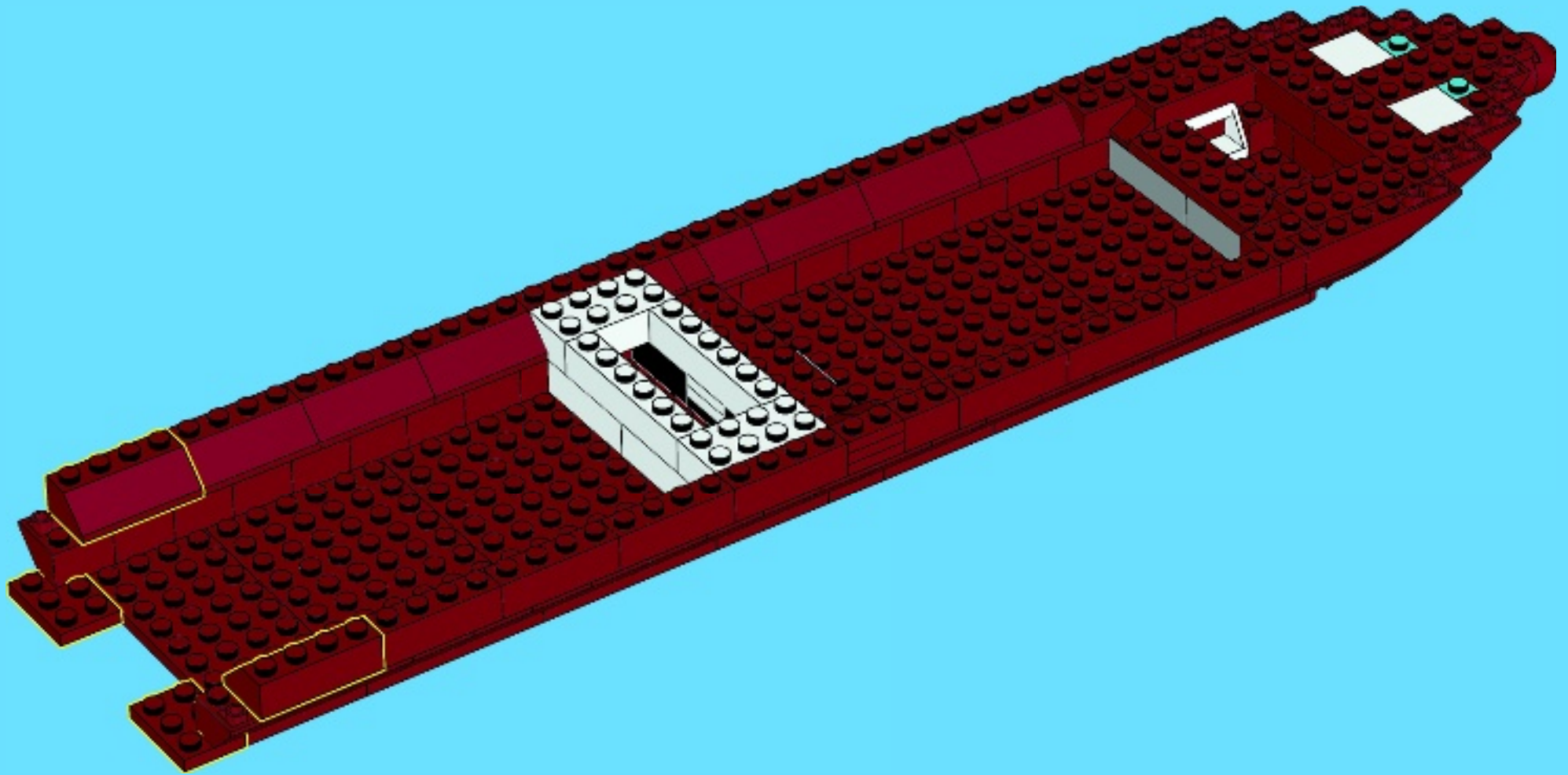



32

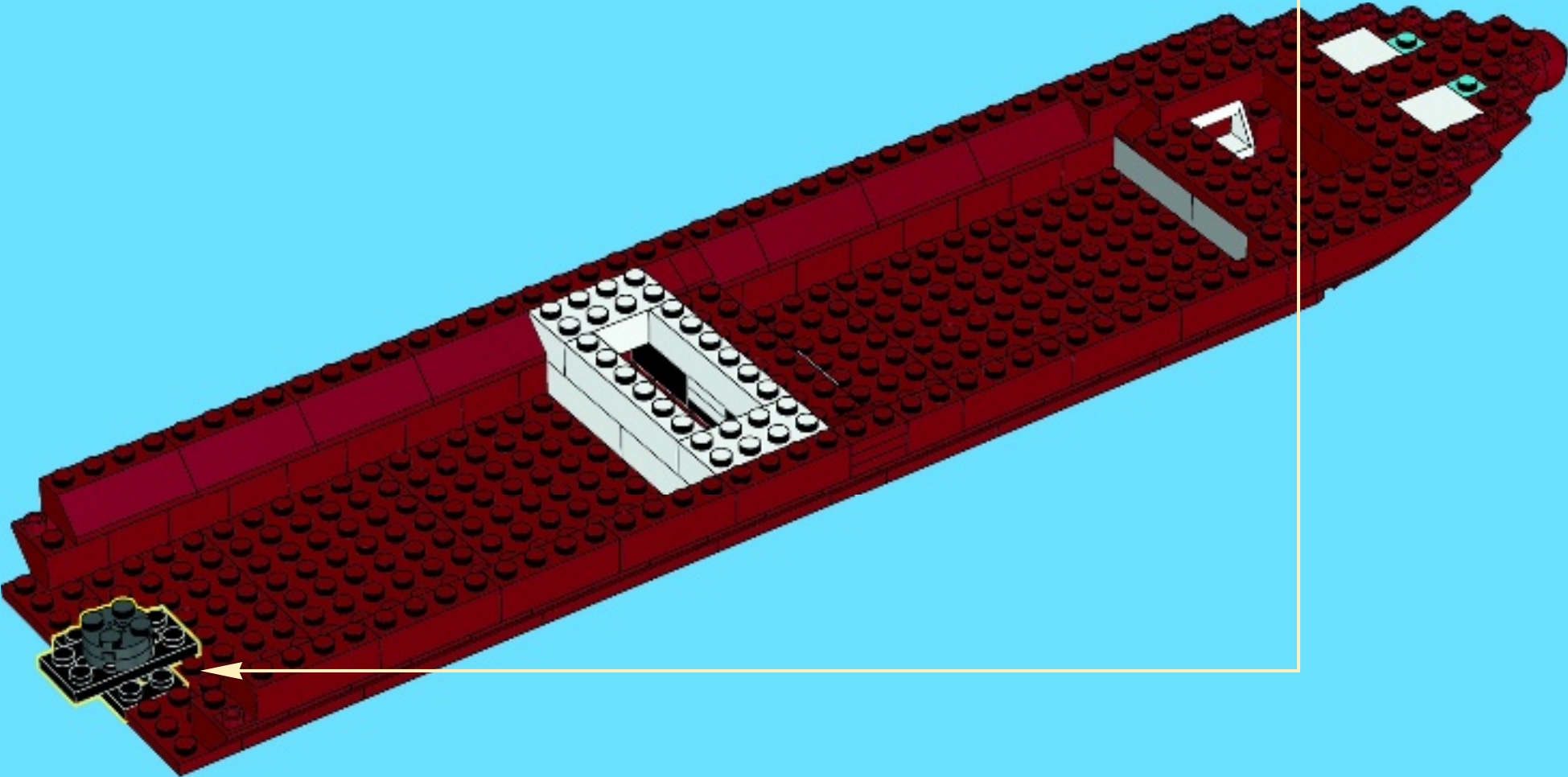
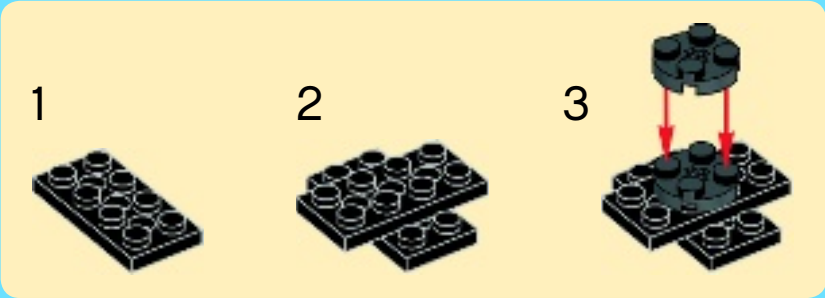

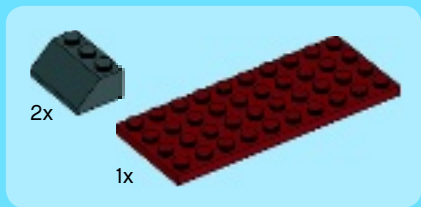

33

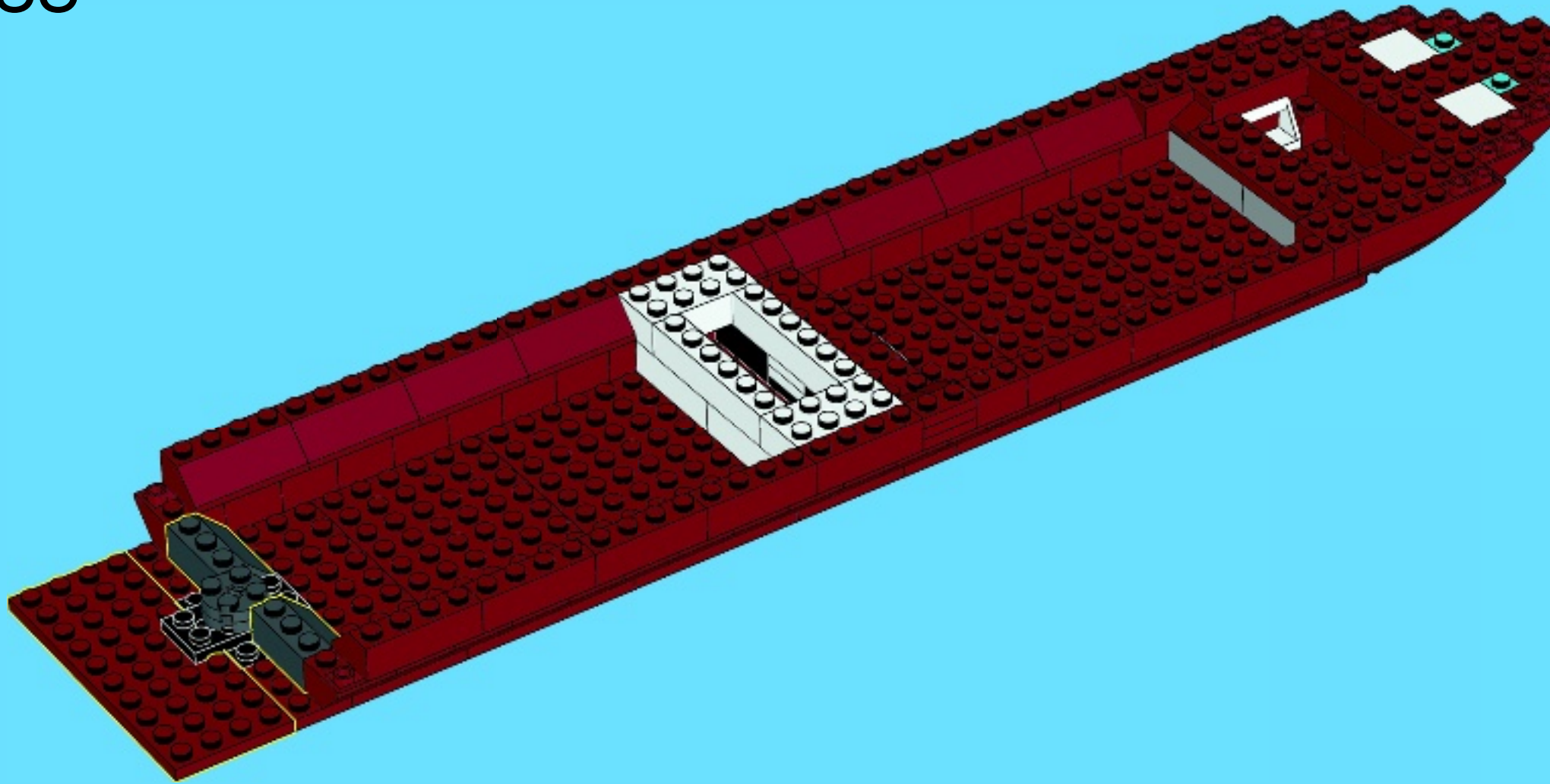



2x



6x

34

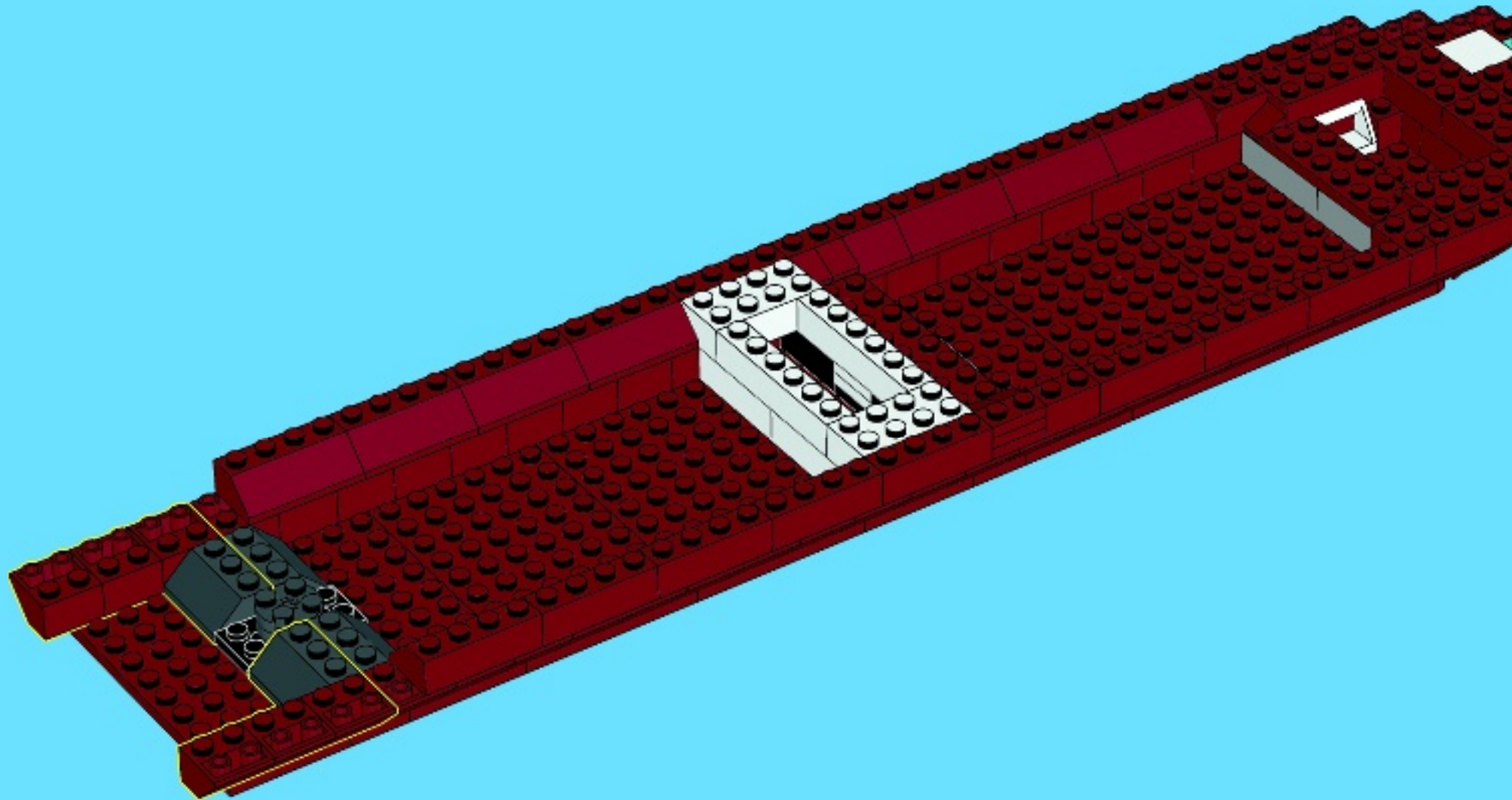

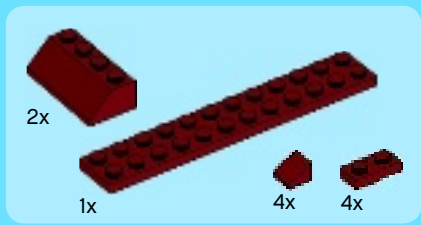

35

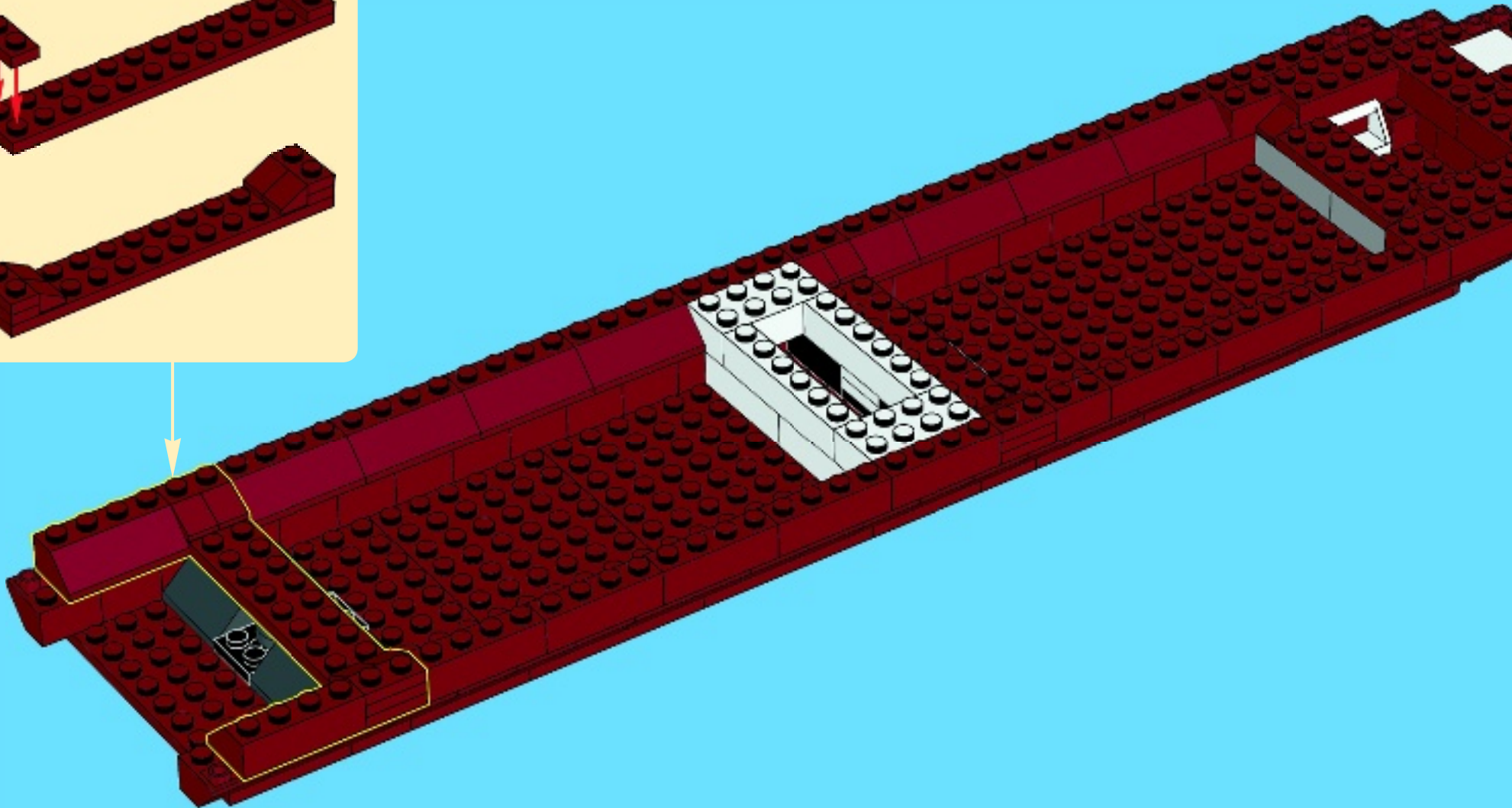
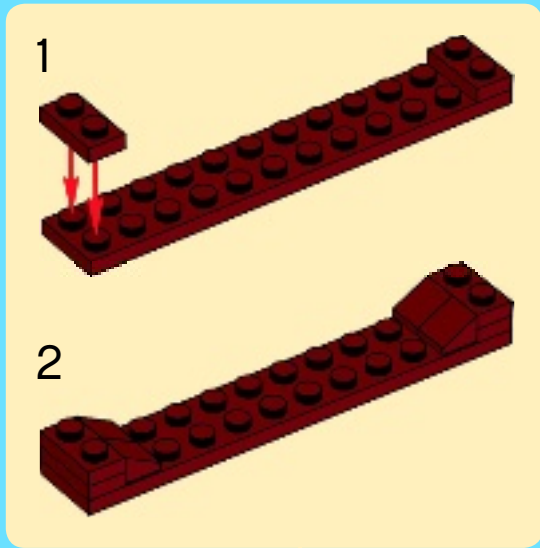



36

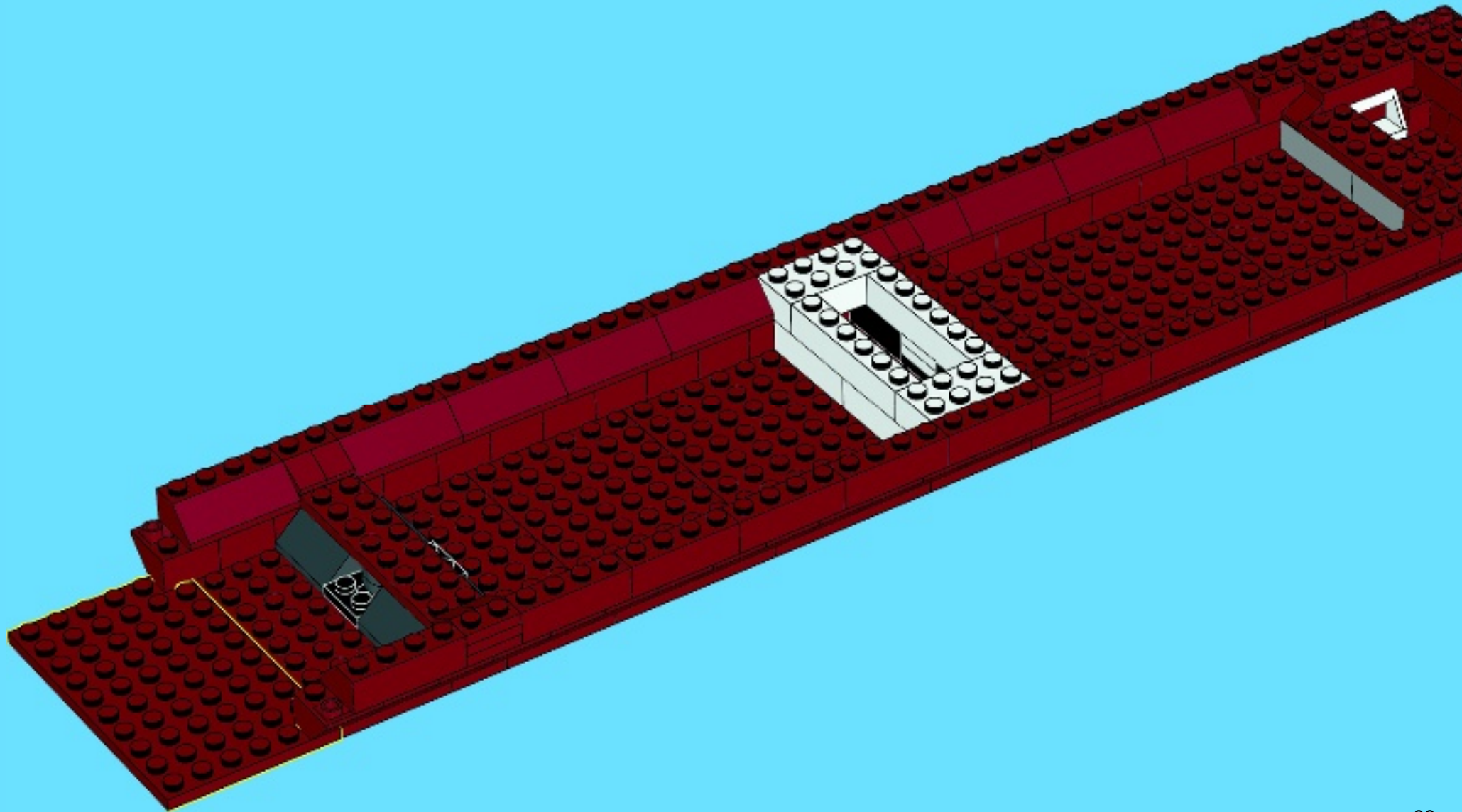



6x

37

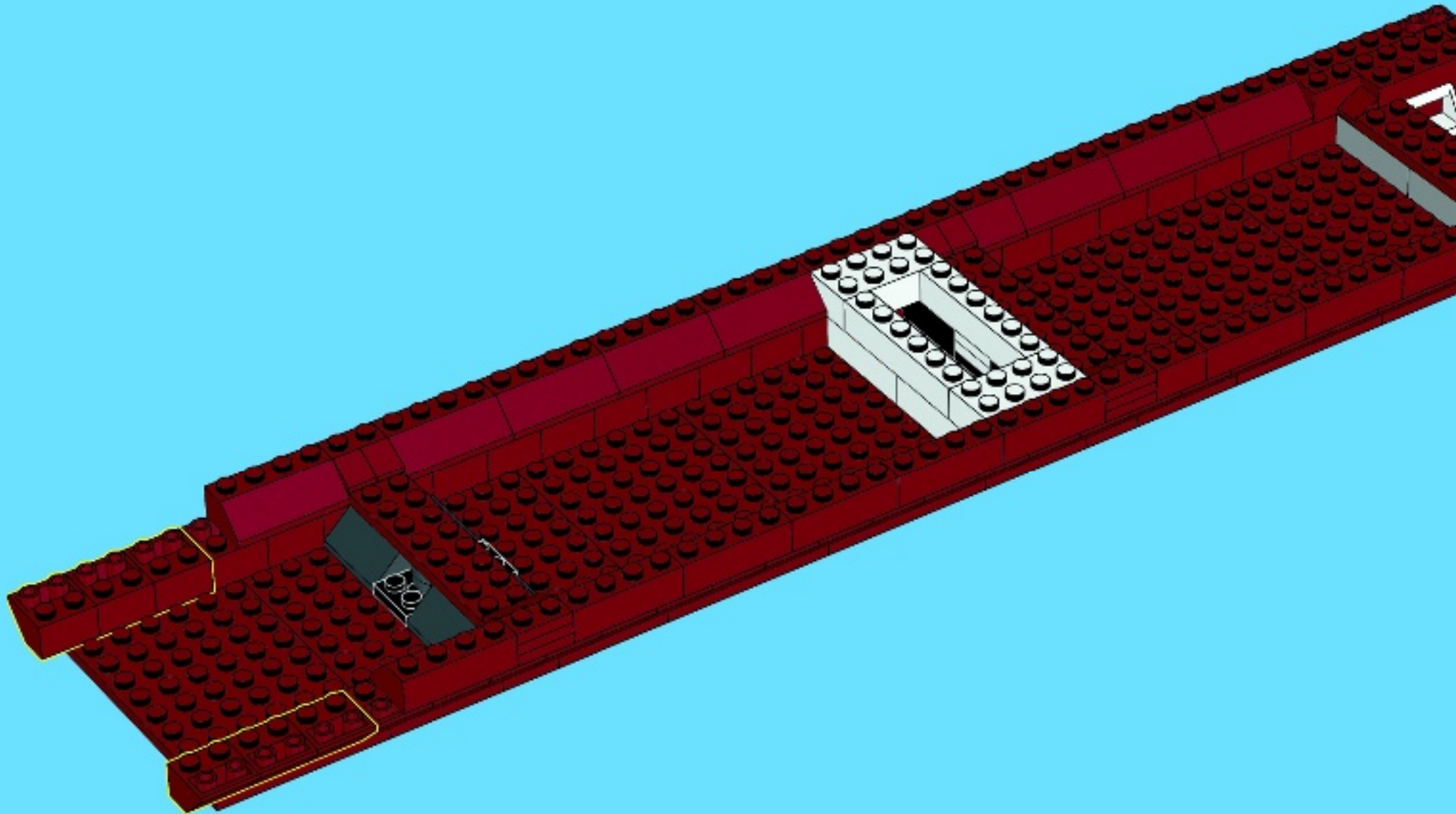

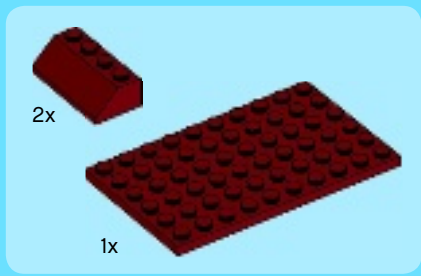

38

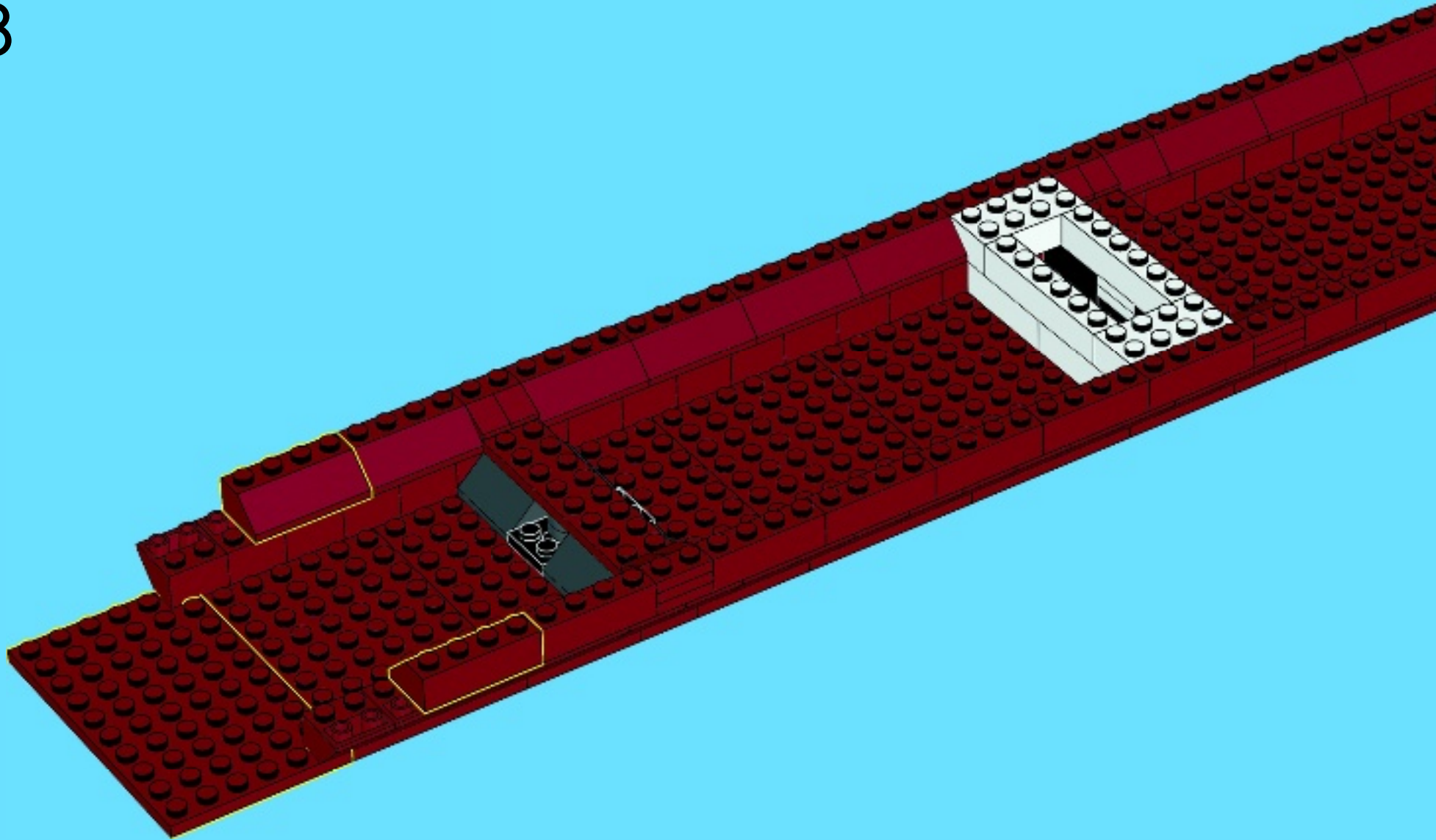



4x

39

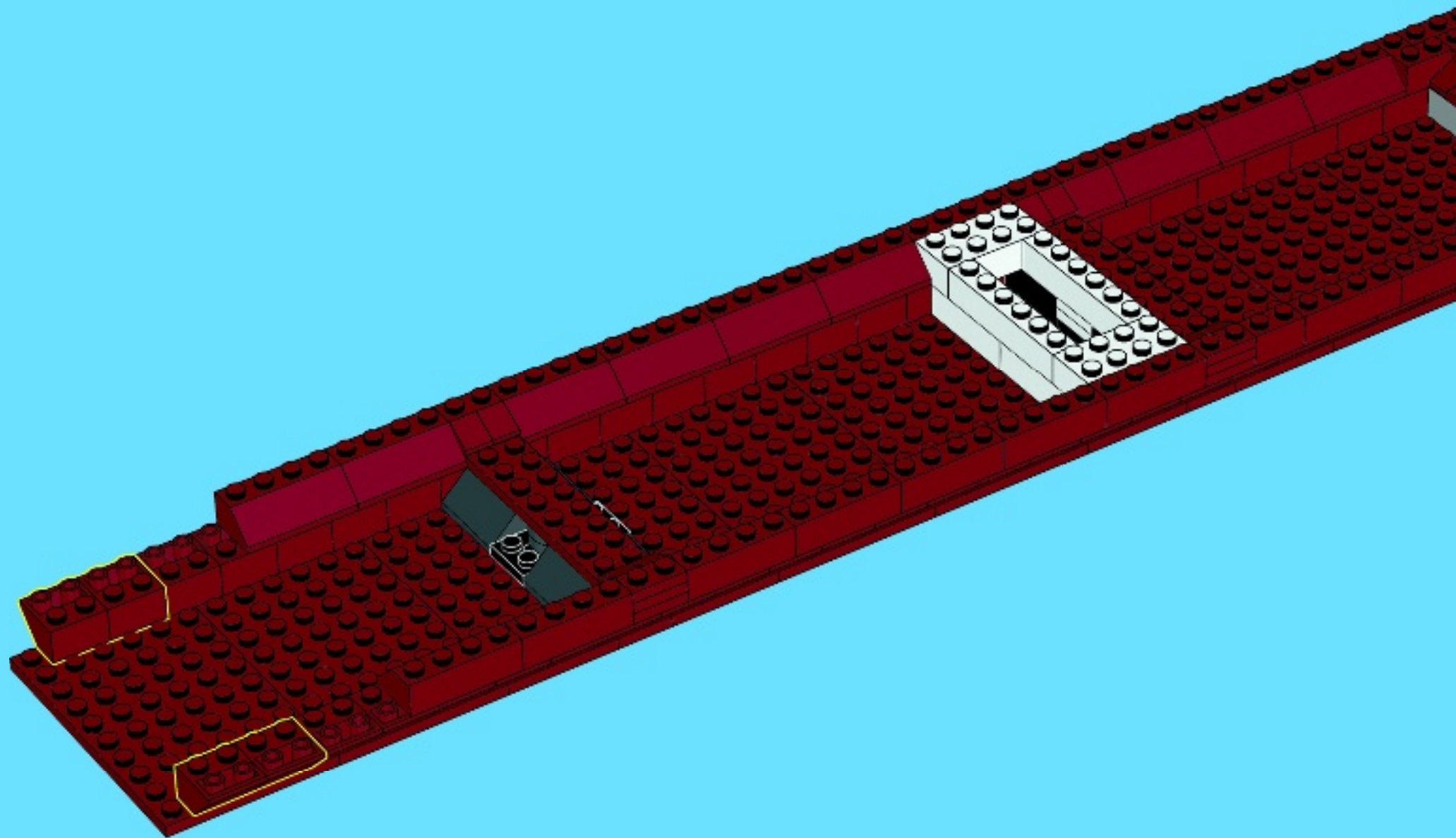



6x



4x



4x

40

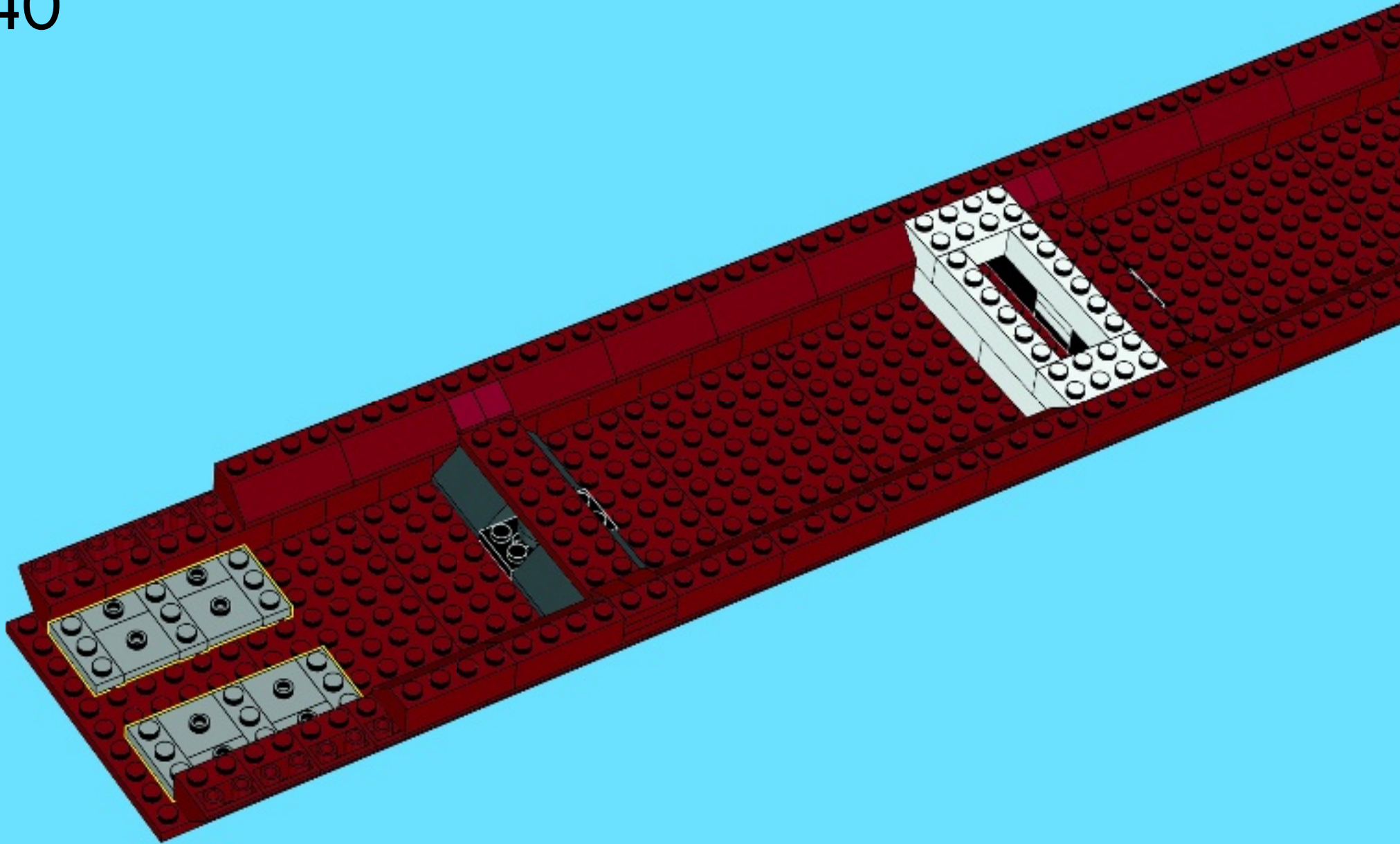



10x



10x

41

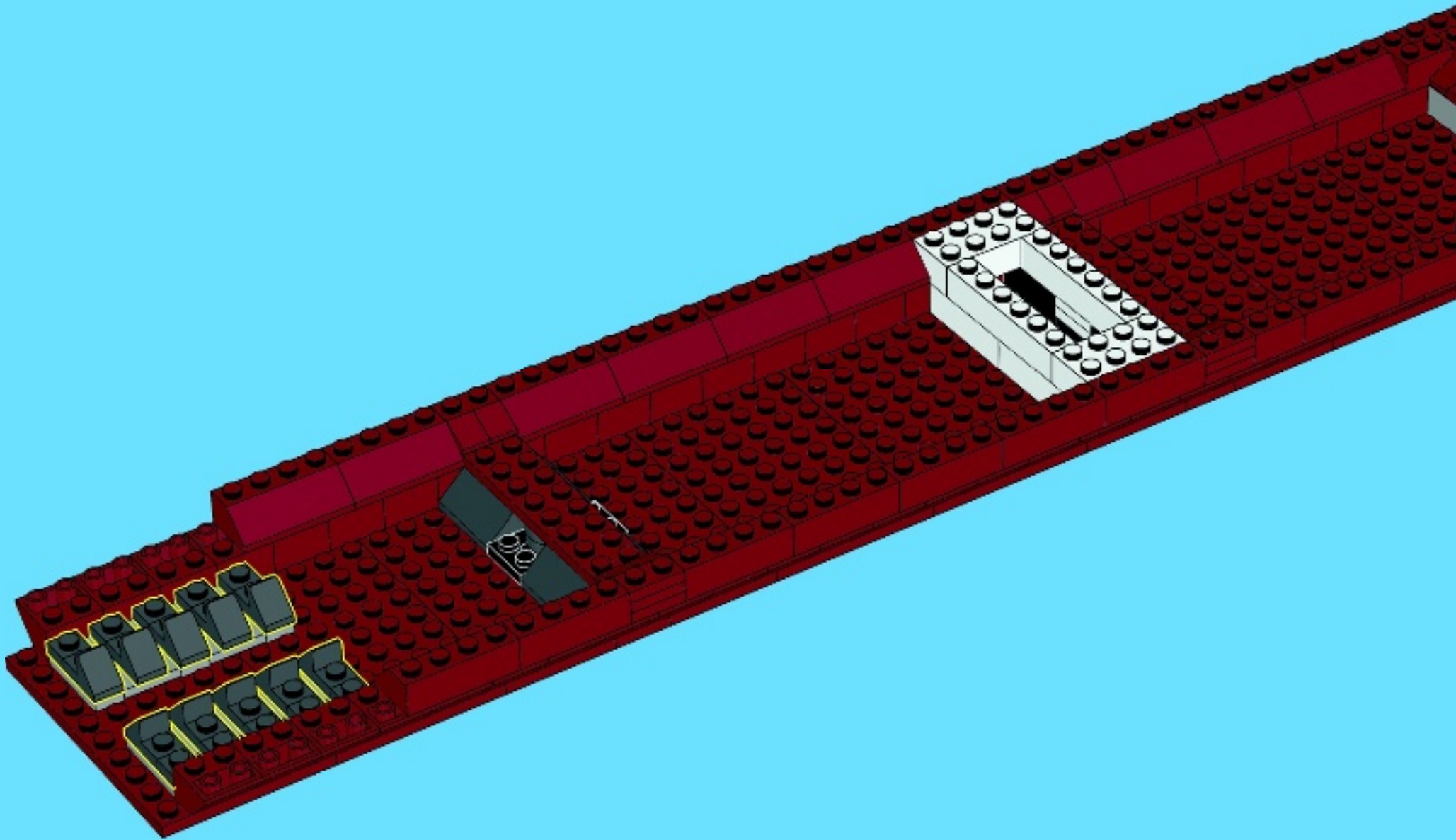

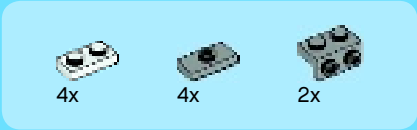

42

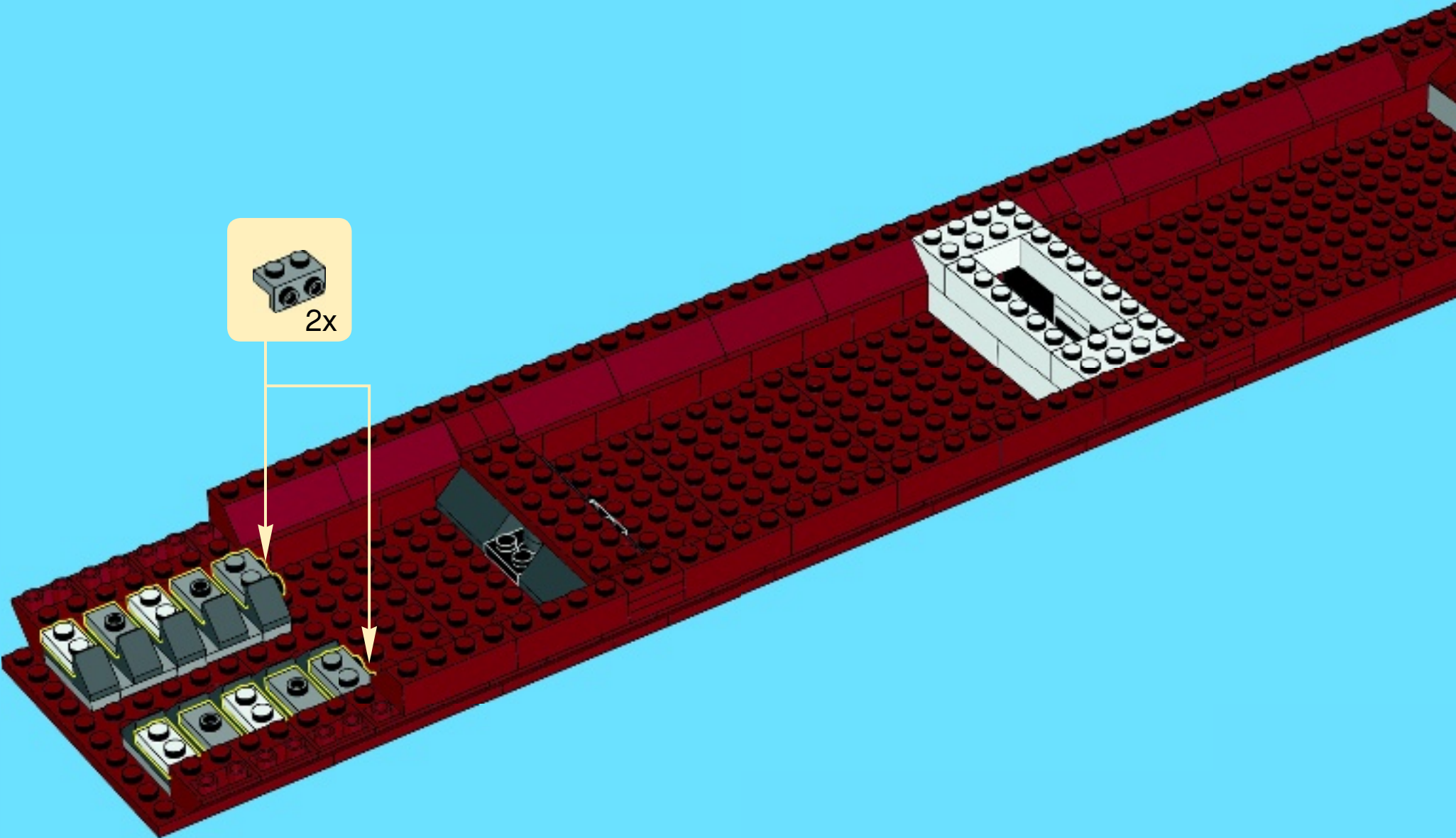



2x

43

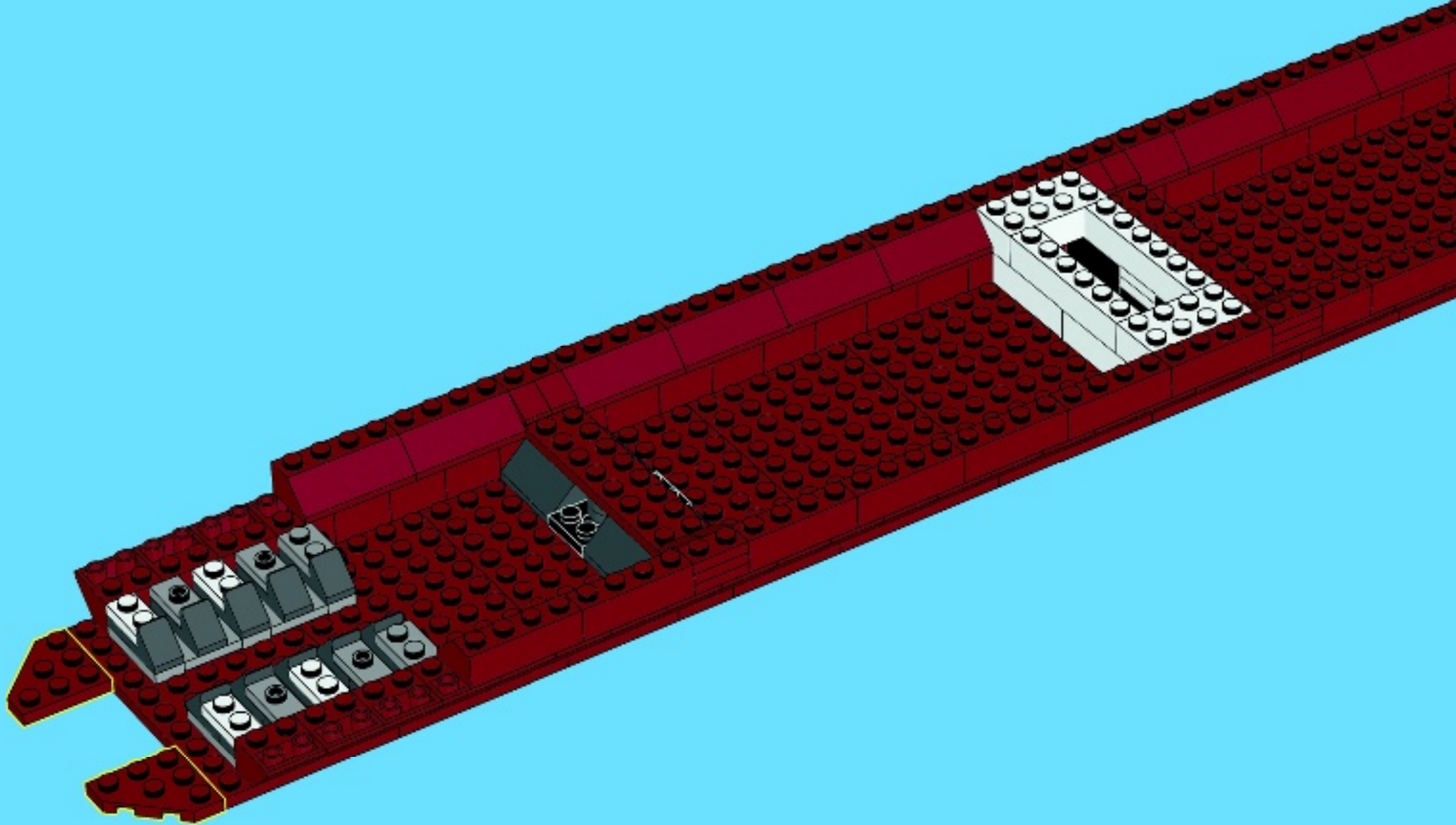

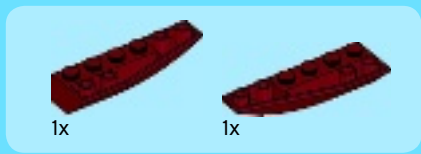

44

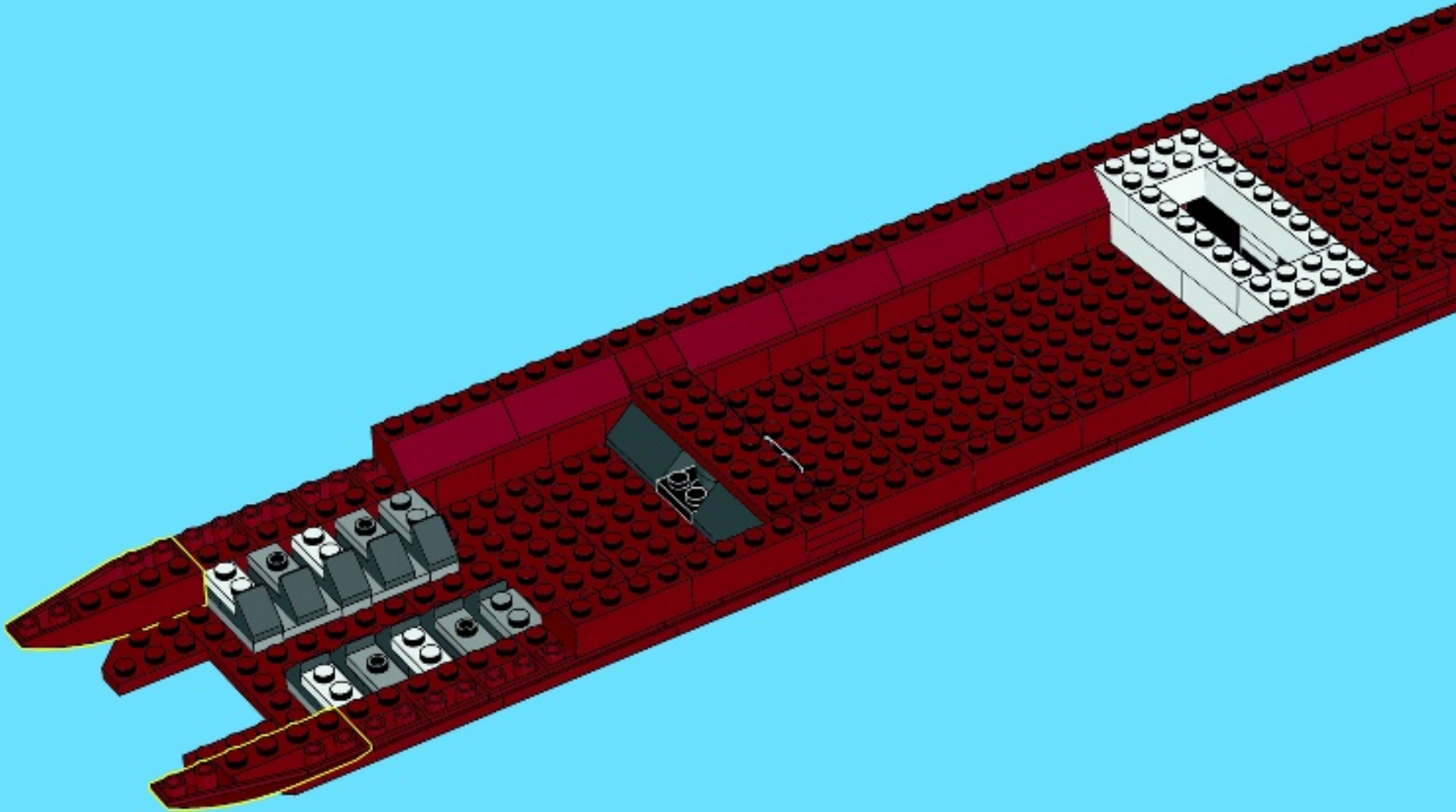

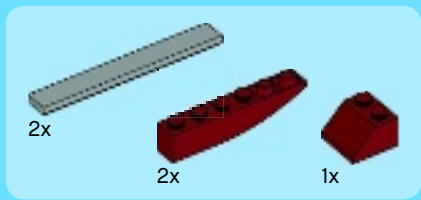

45

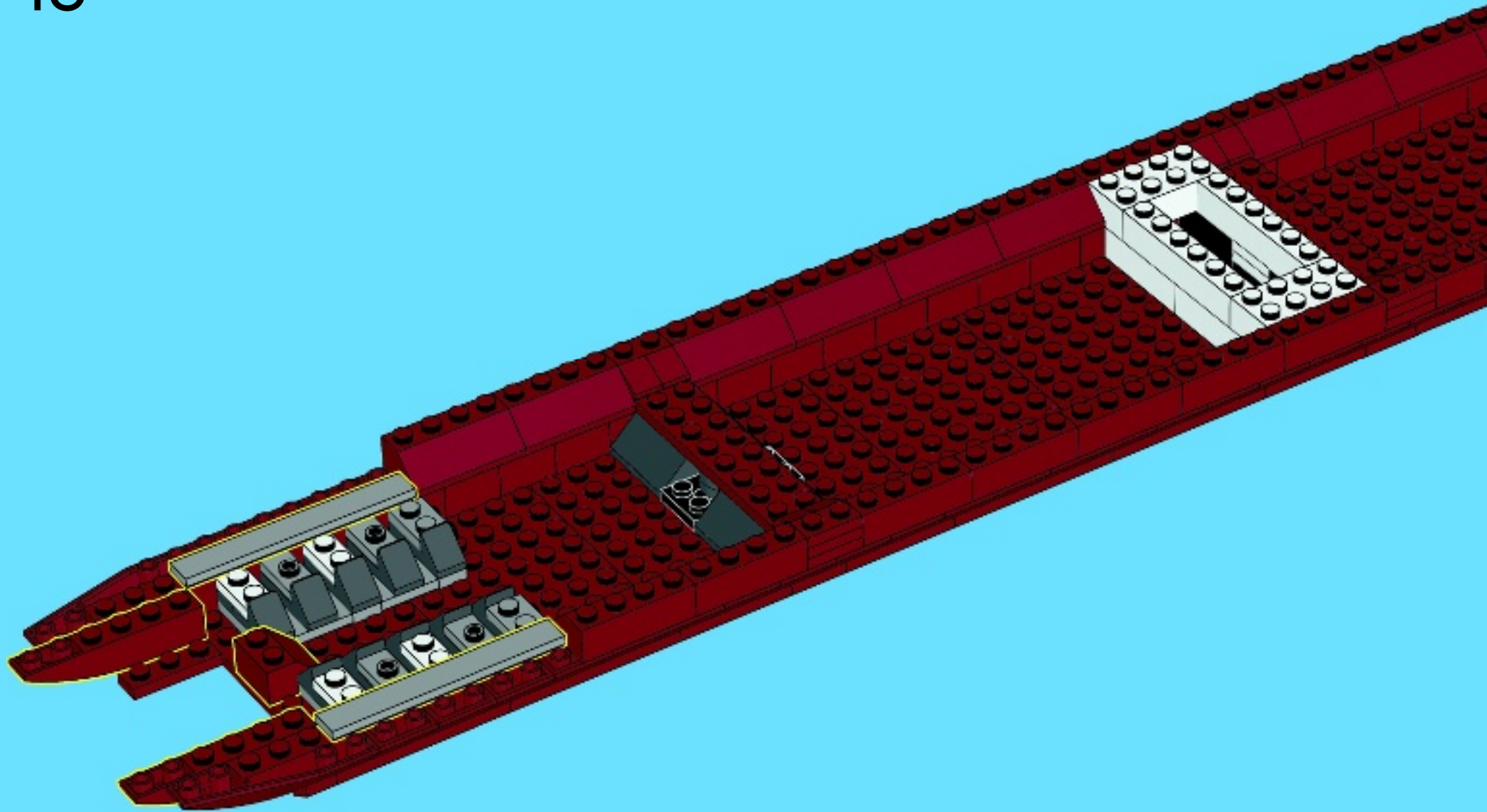

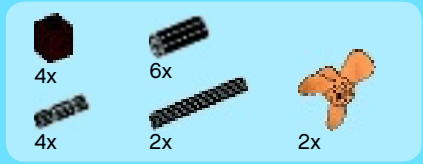

46

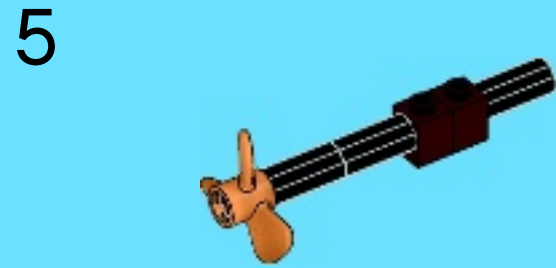
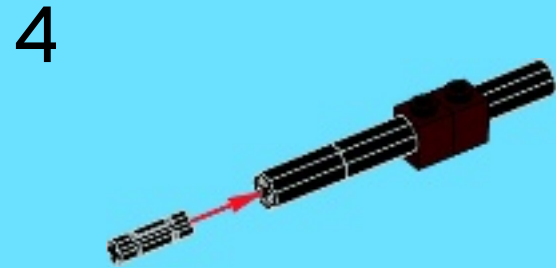
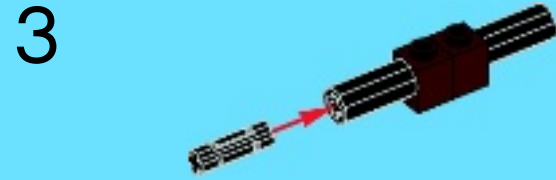
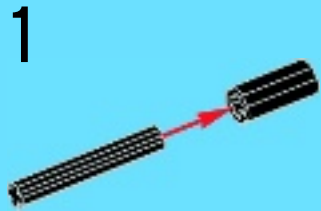

2x

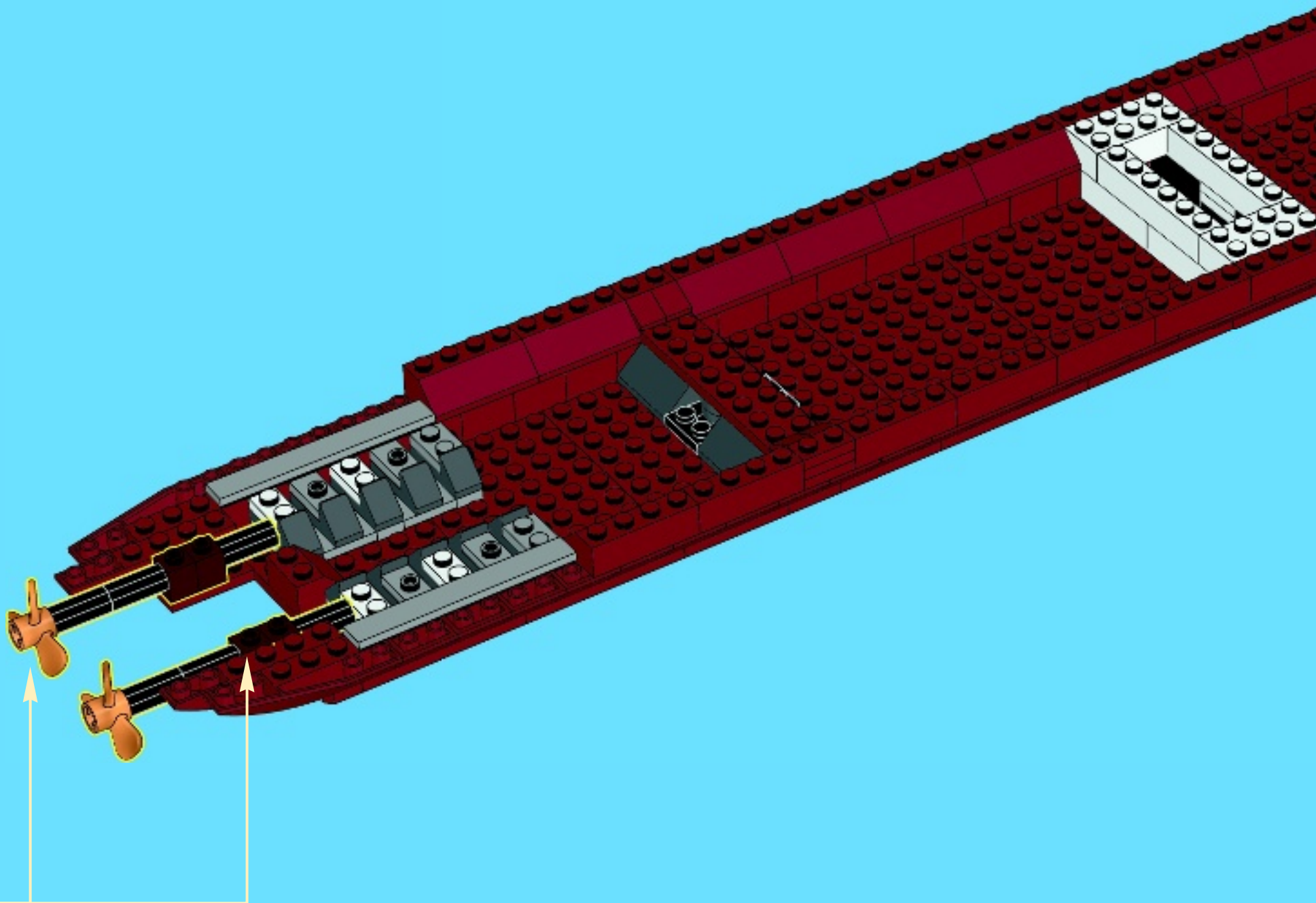

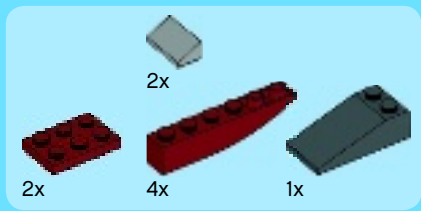

47

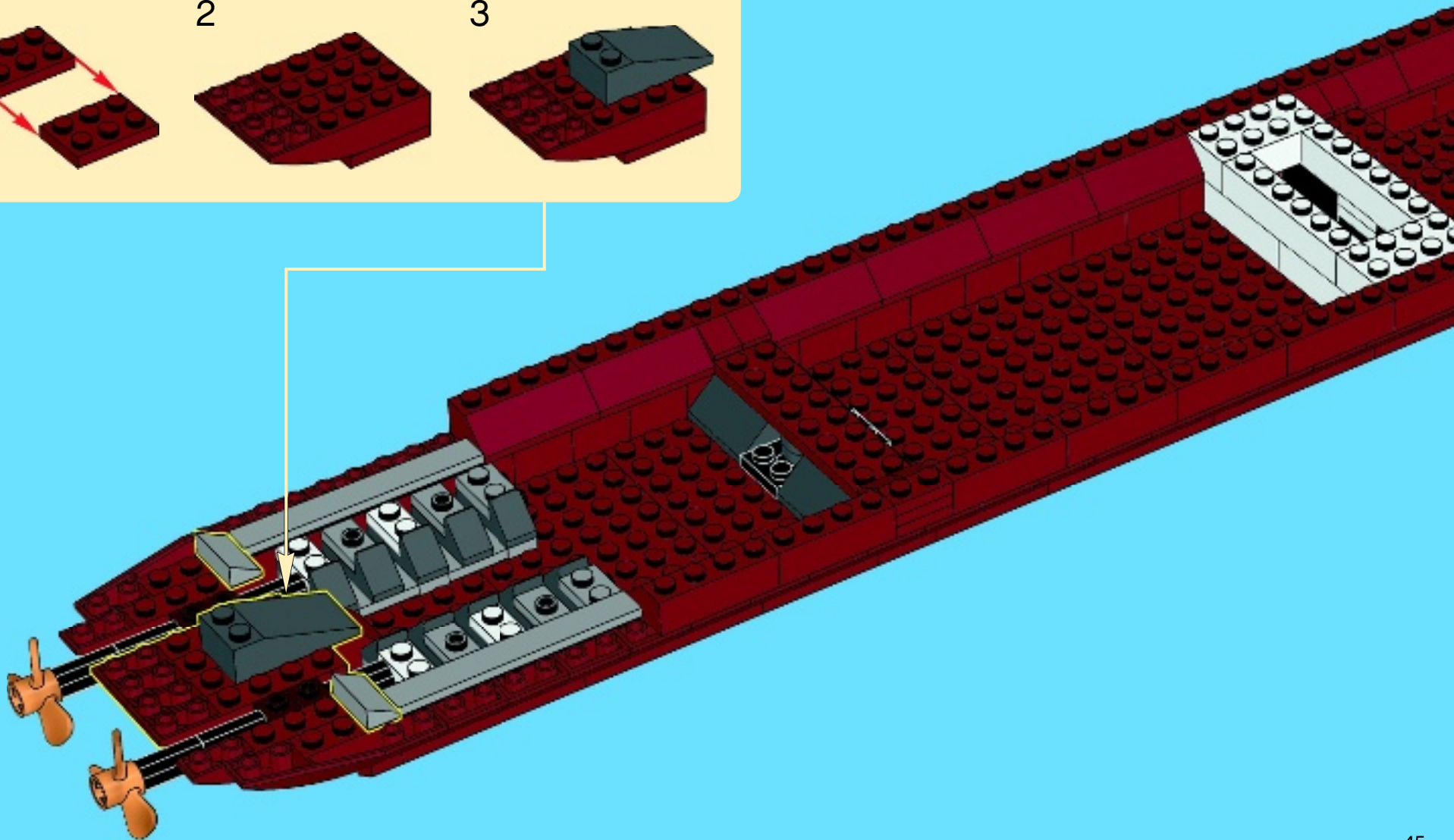

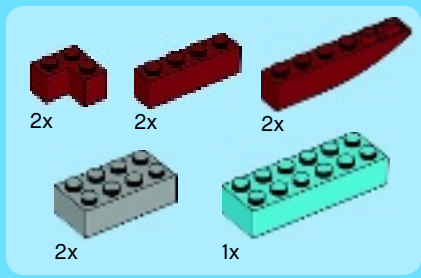

48

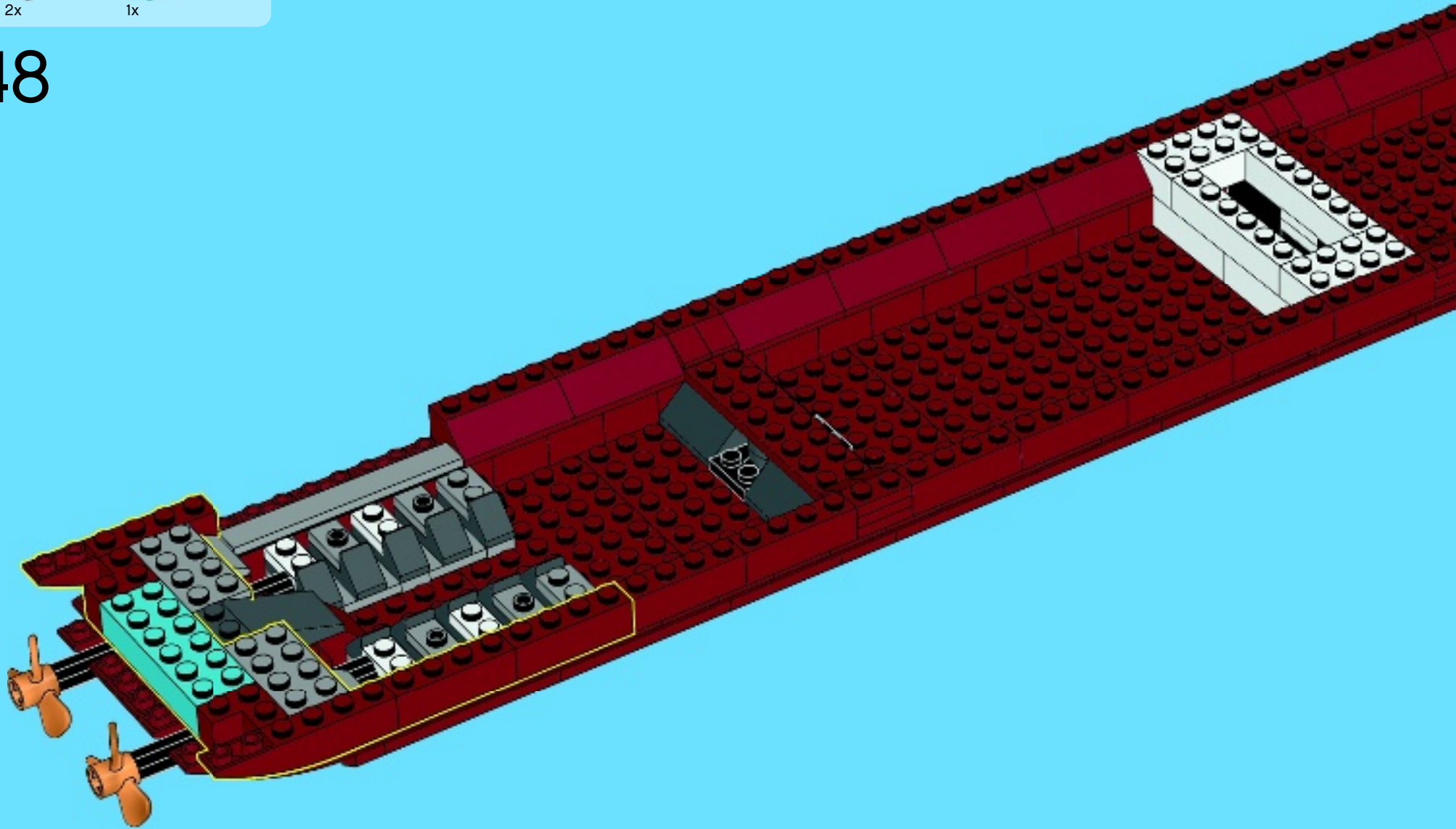

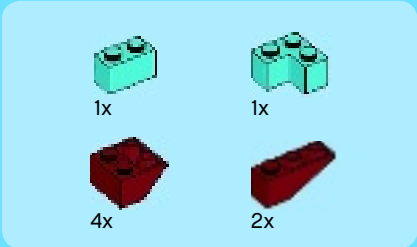

49

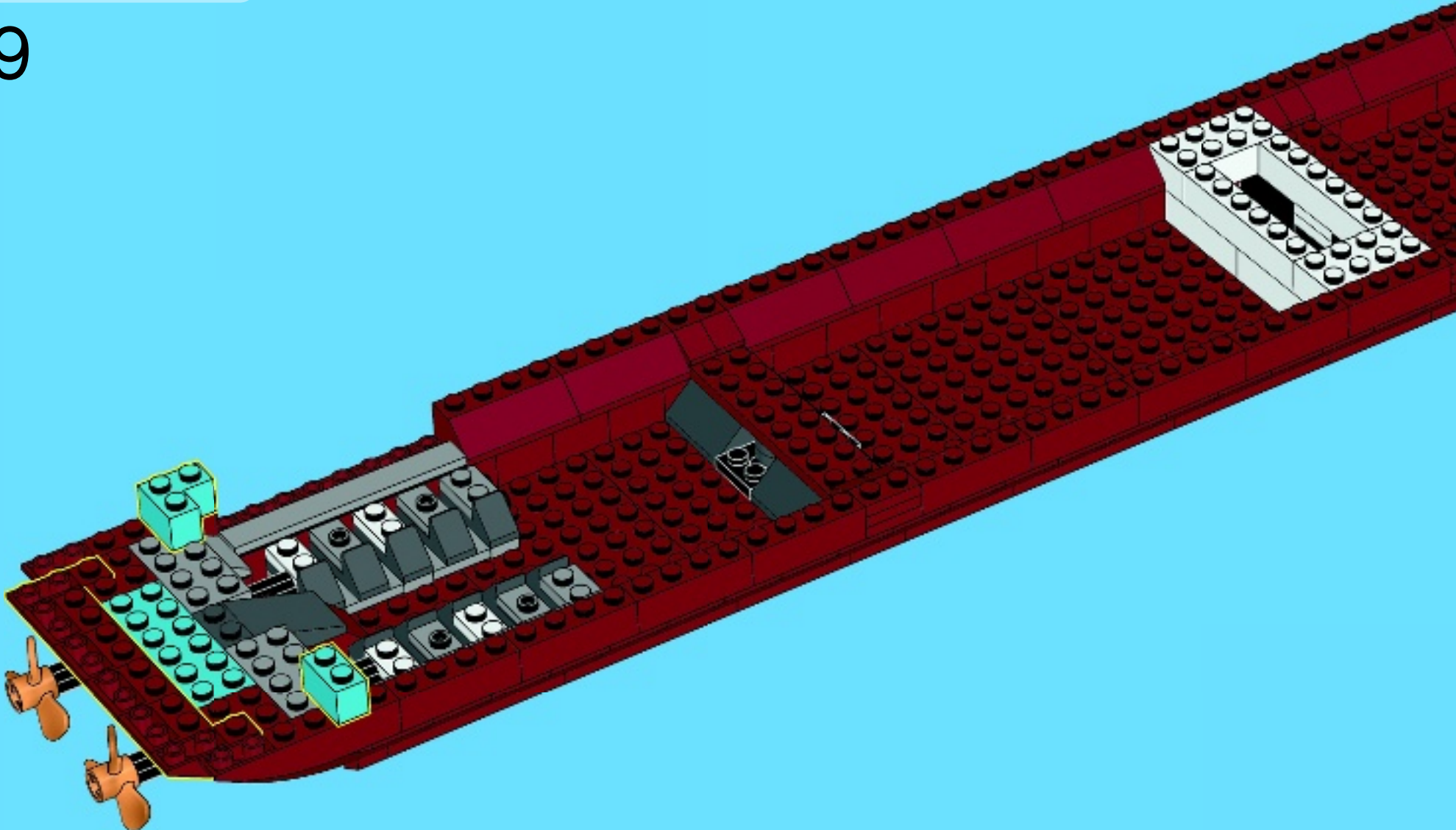

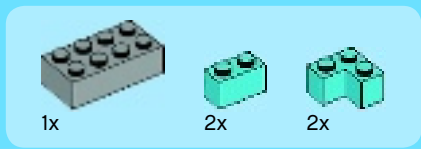

50

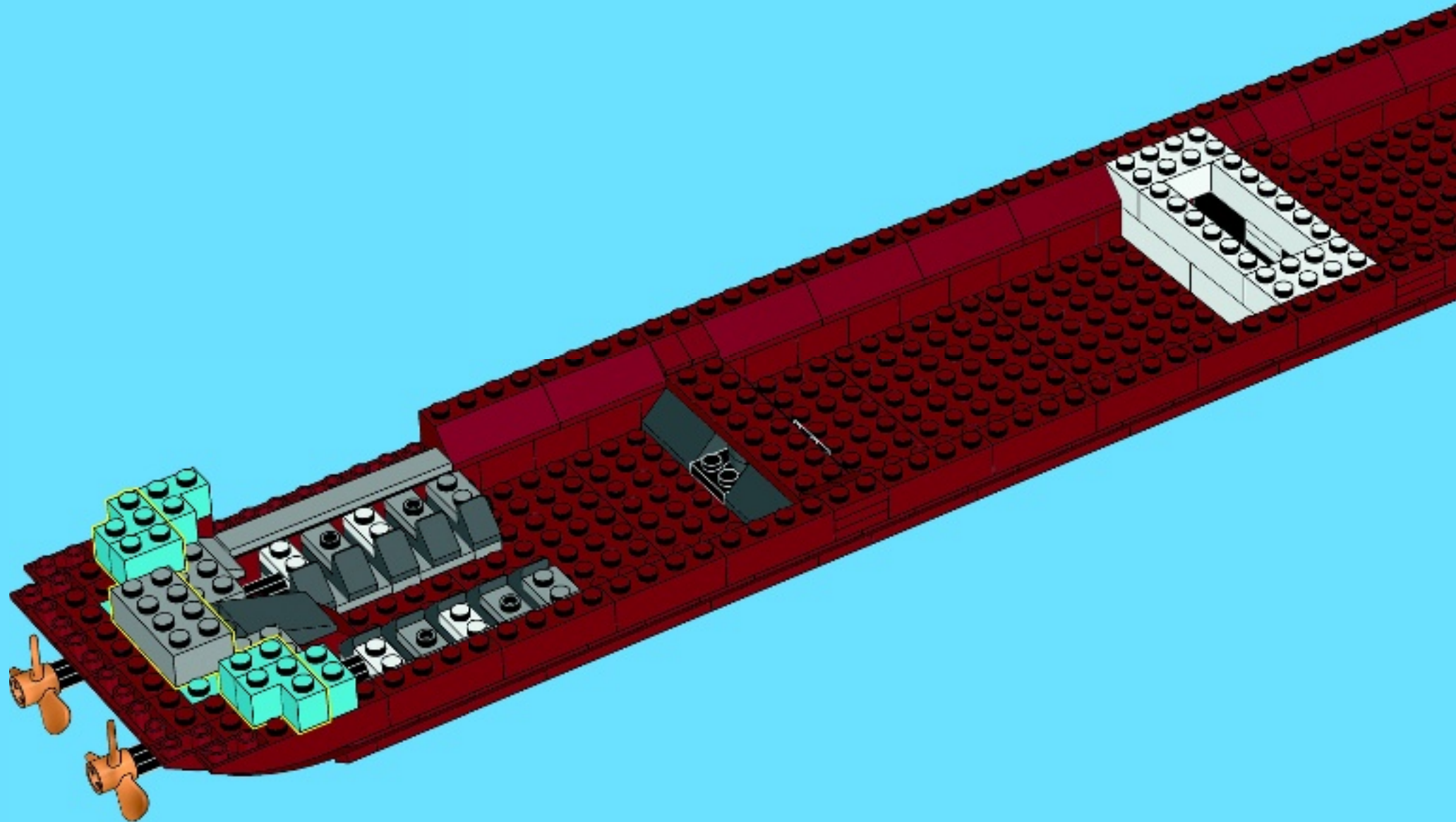

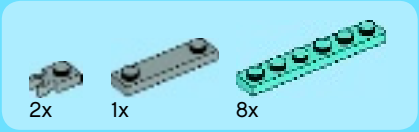

51

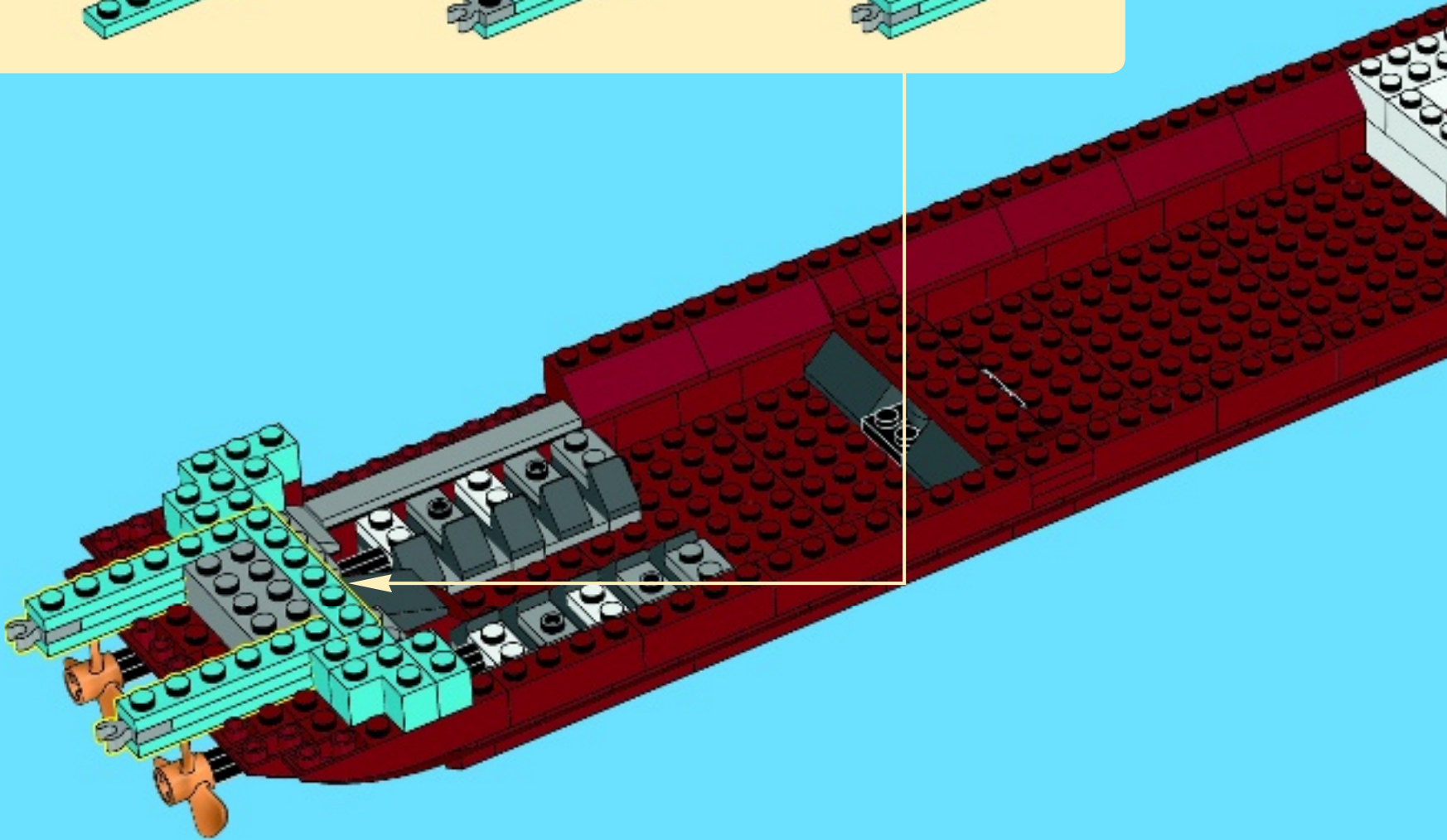
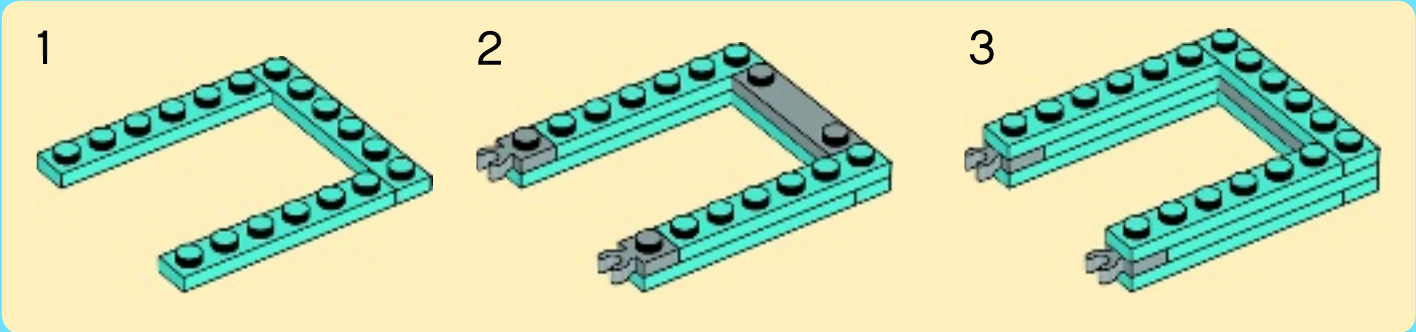

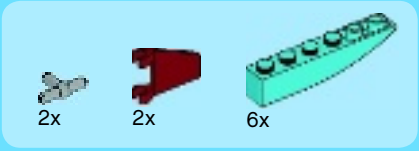

52

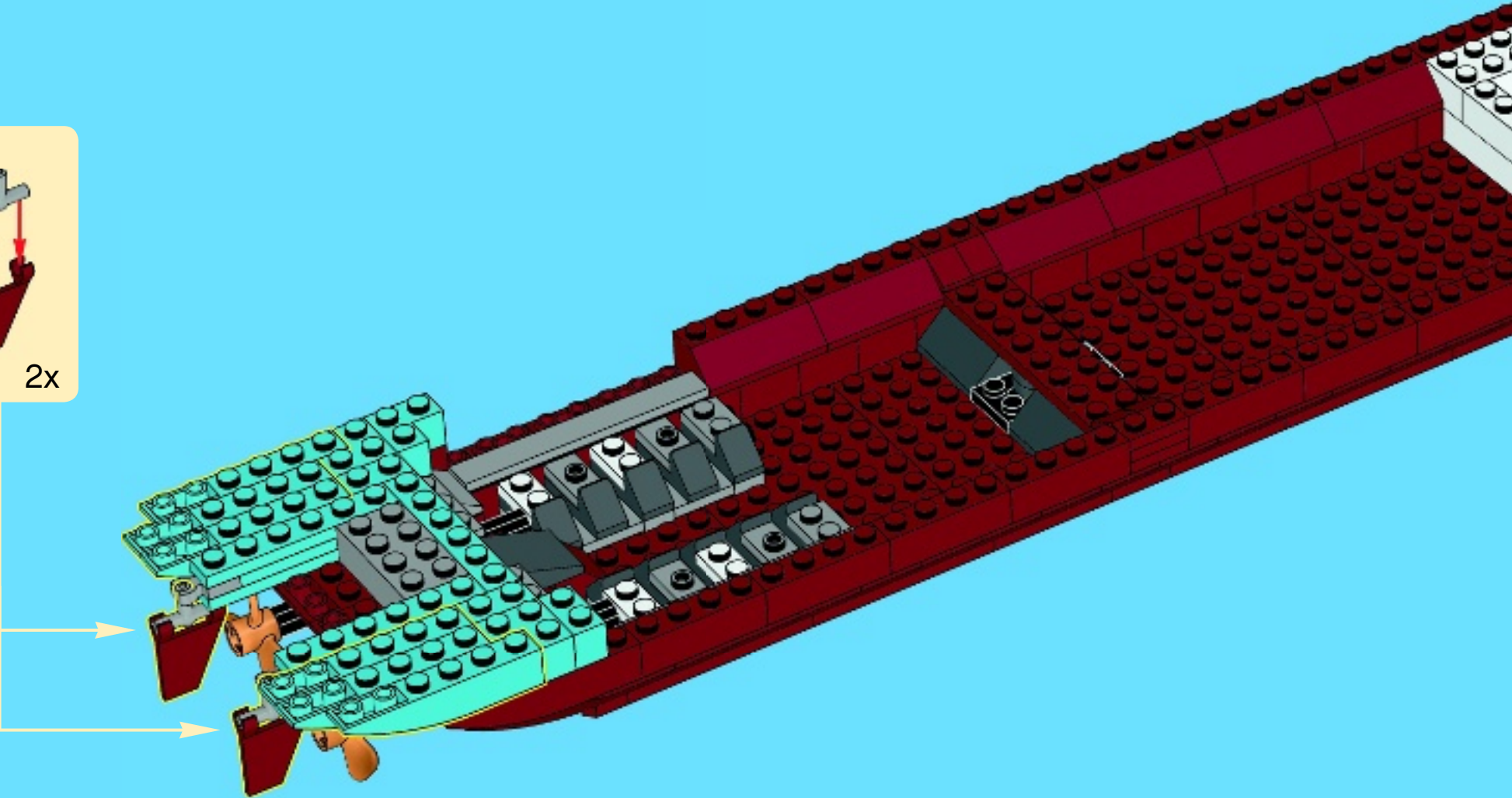
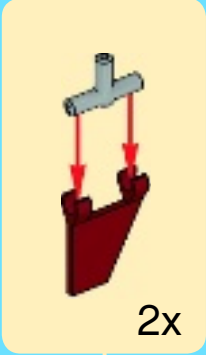

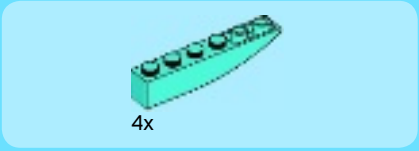

53

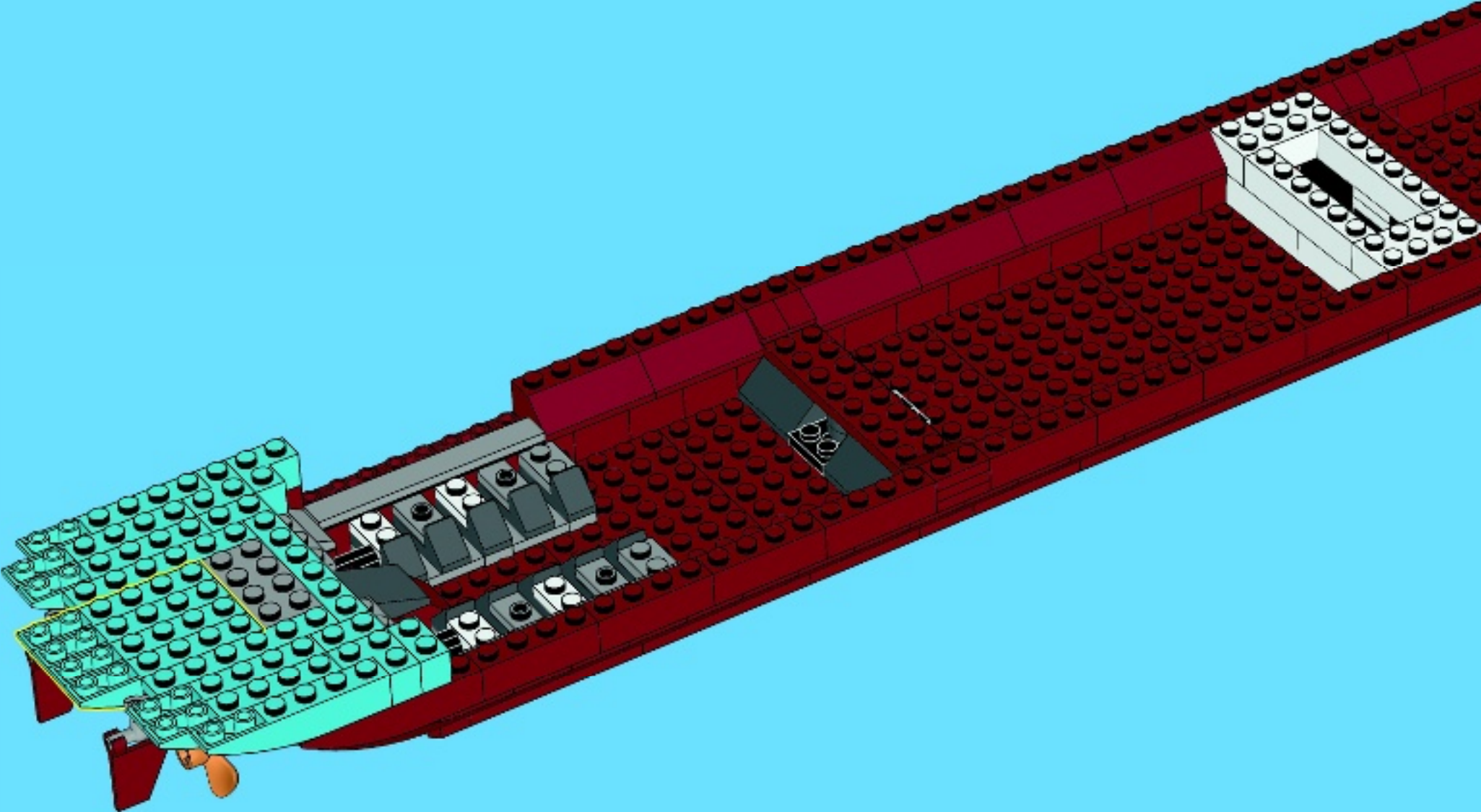

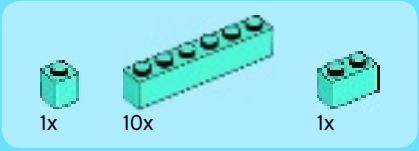

54

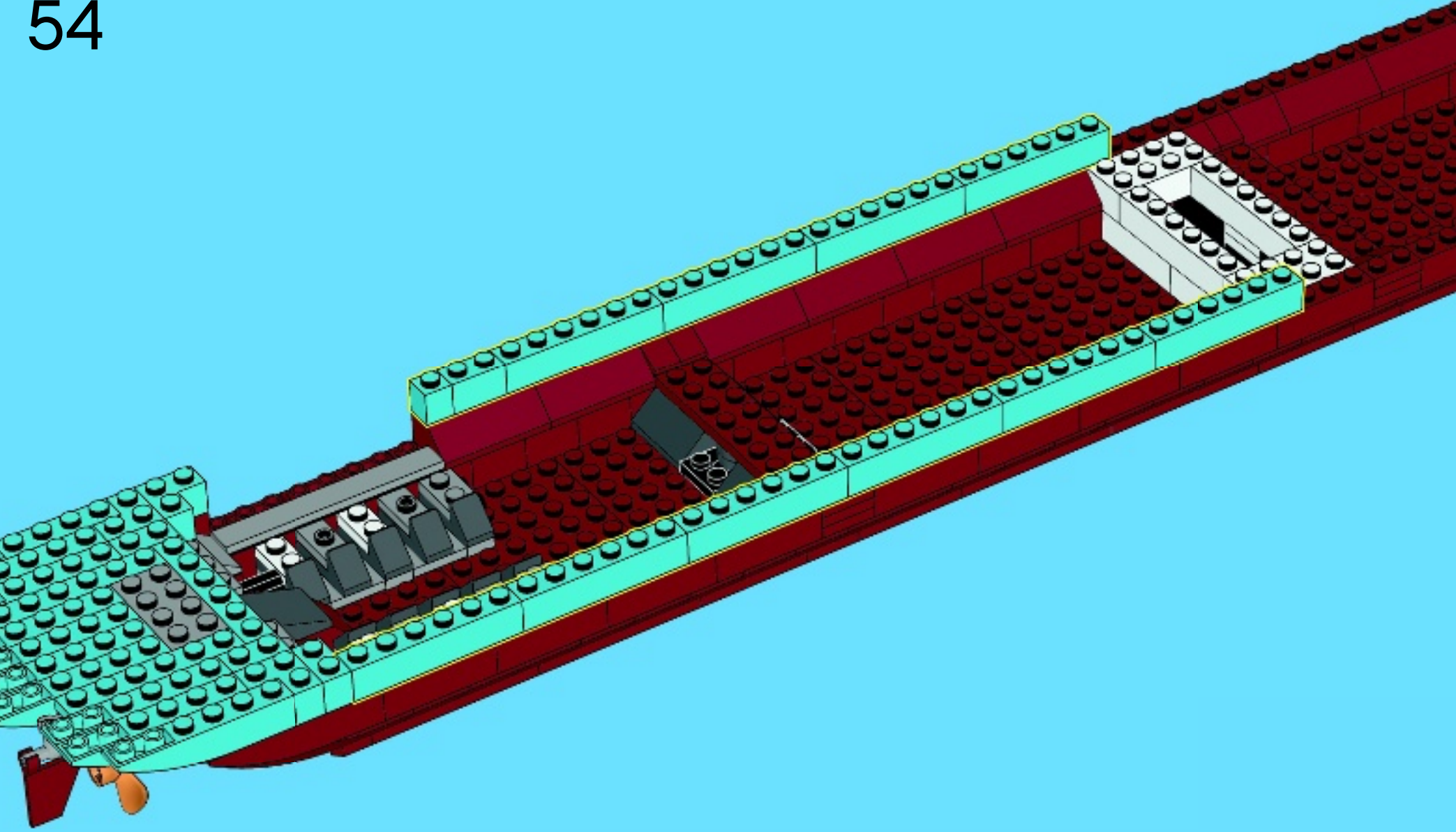

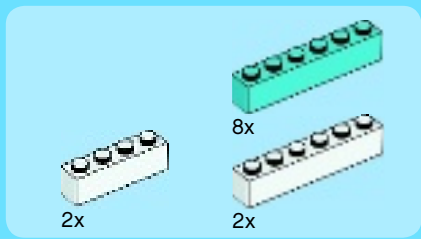

55

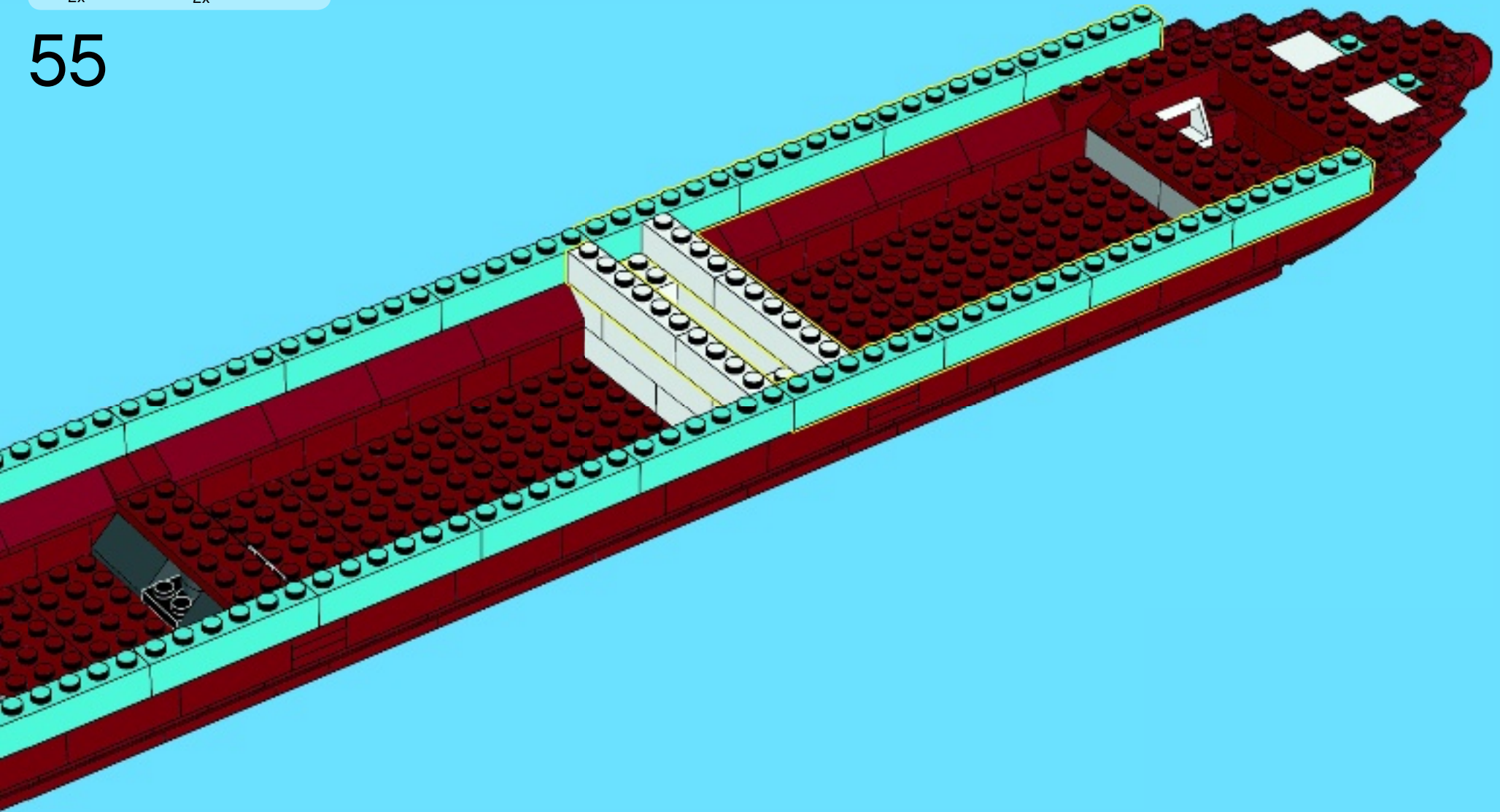

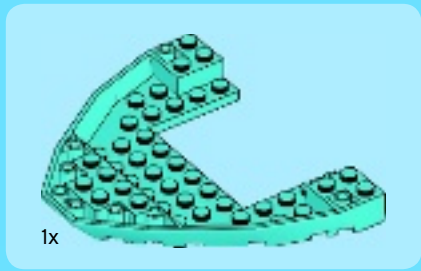

56

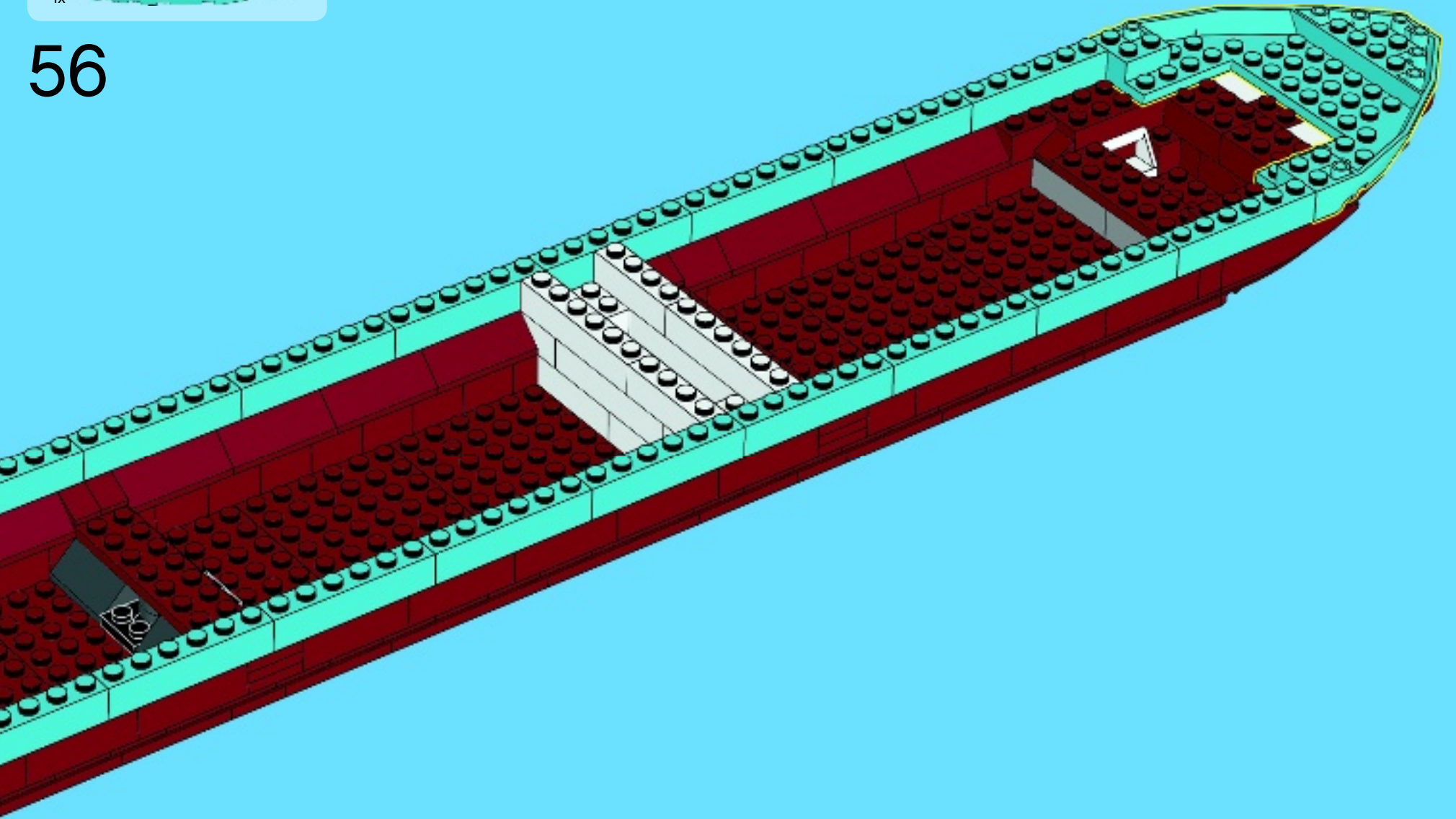

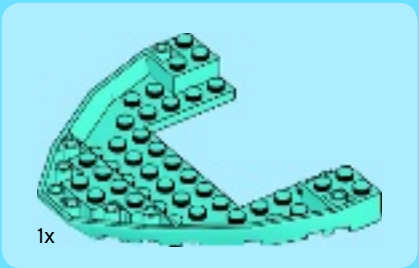

57

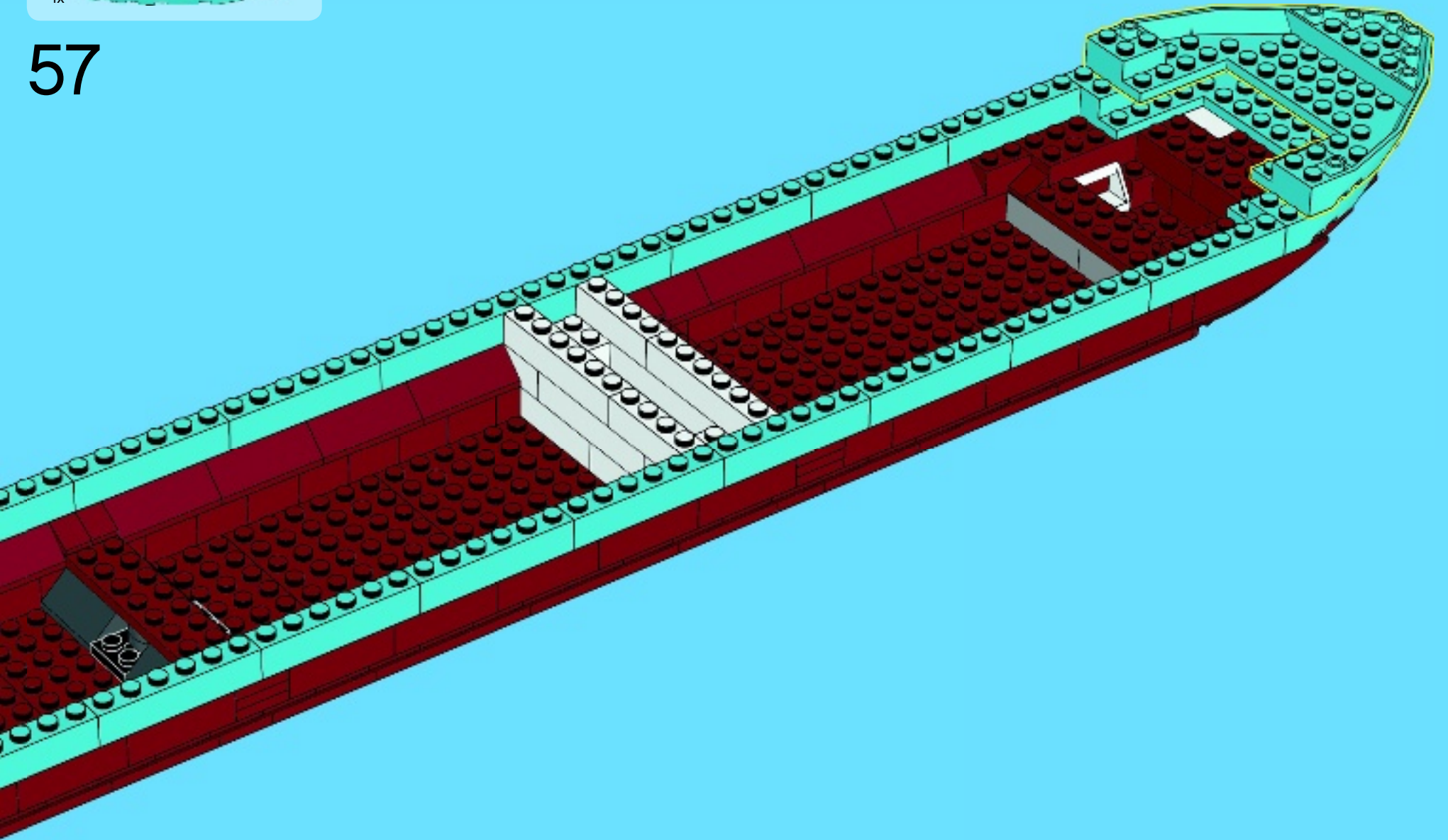

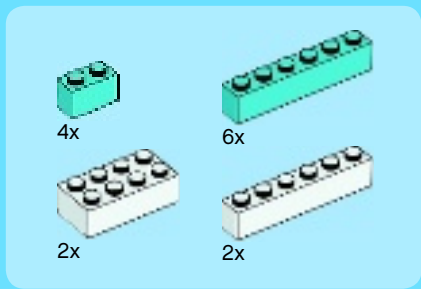

58

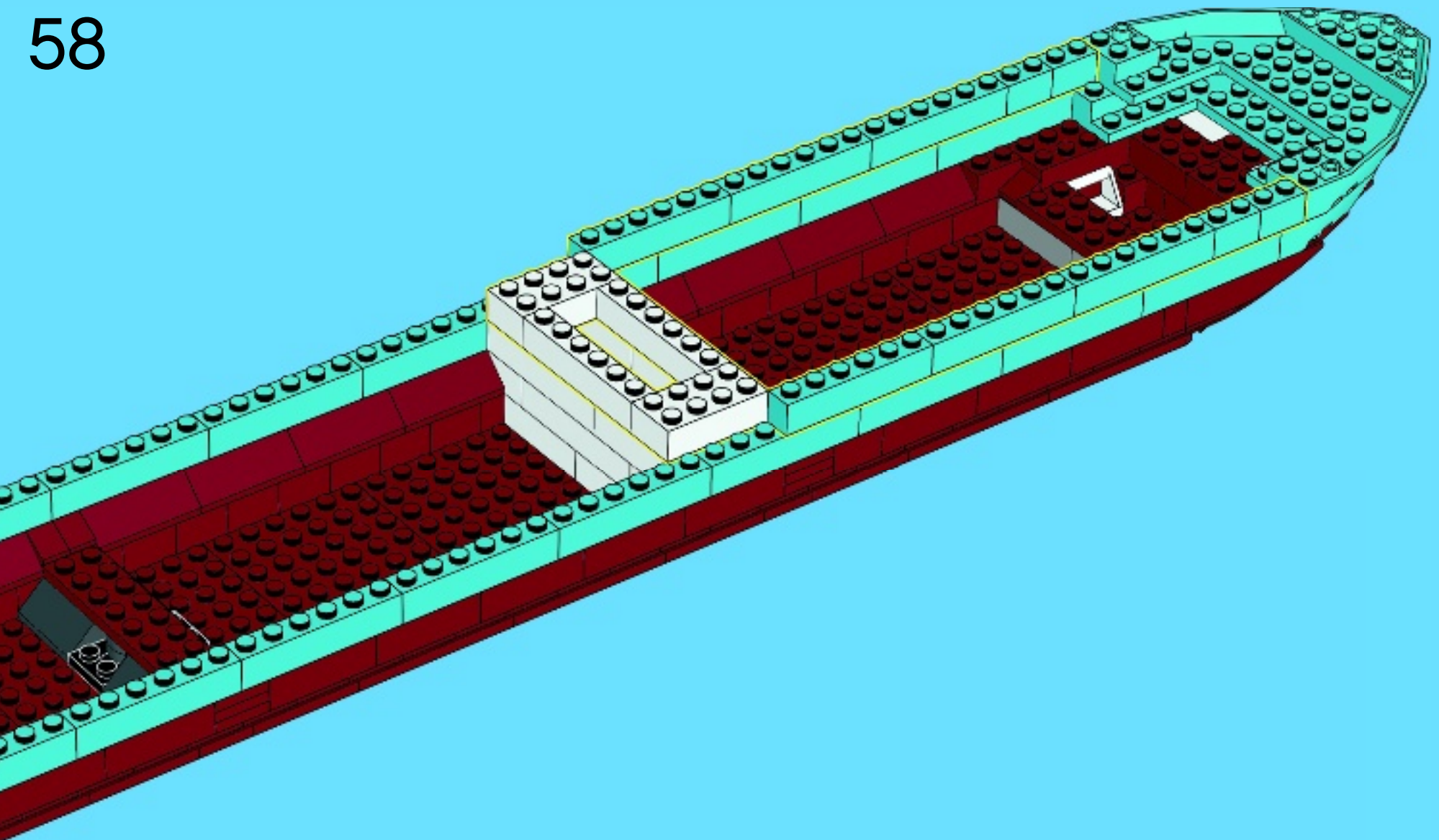

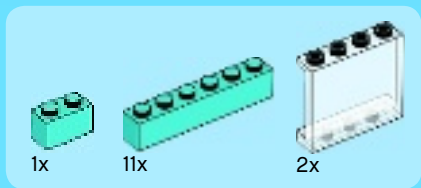

59

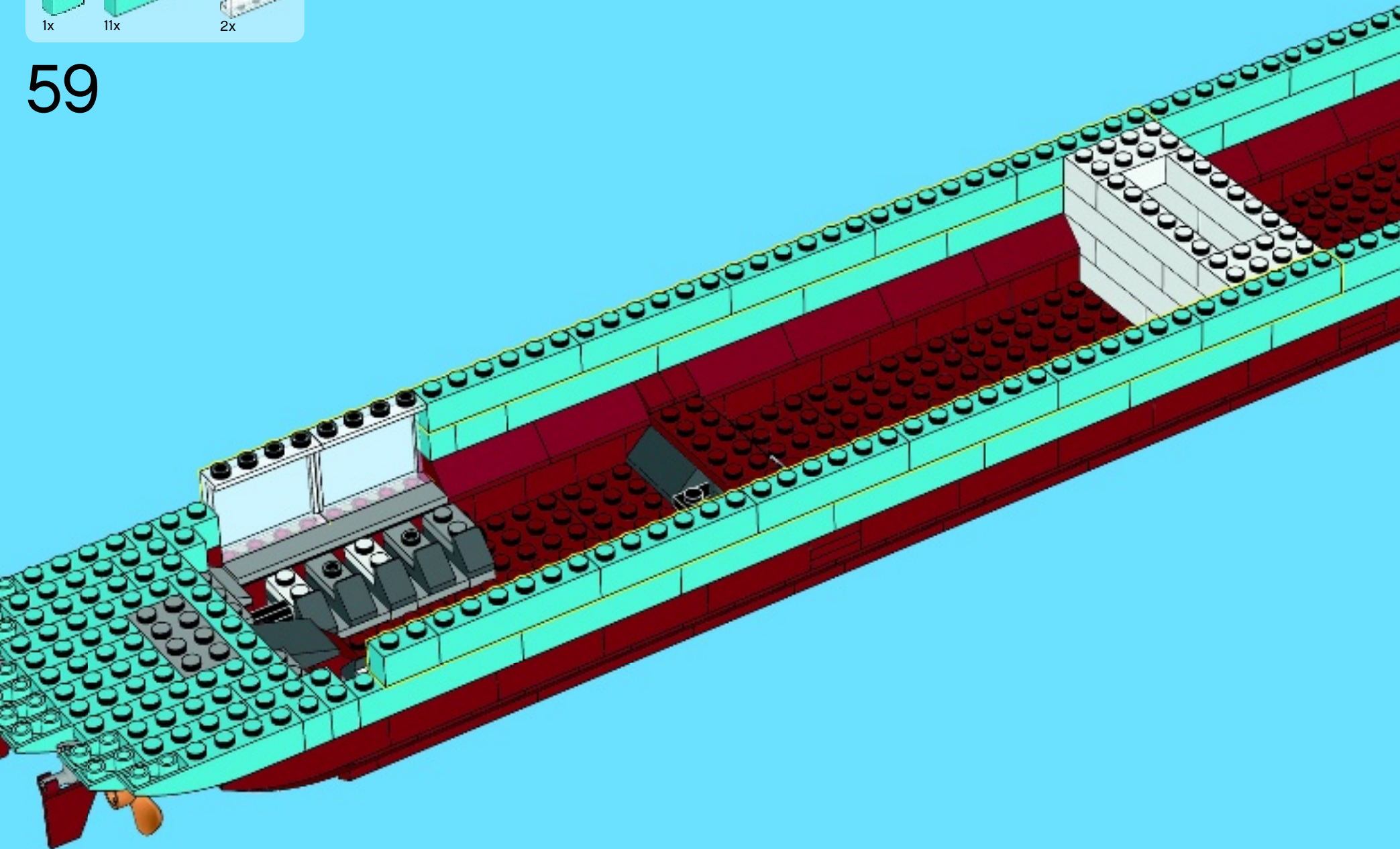

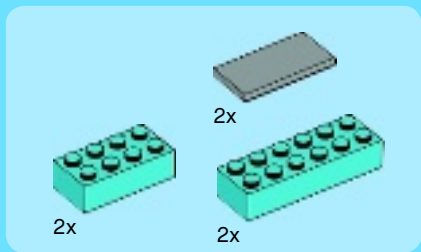

60

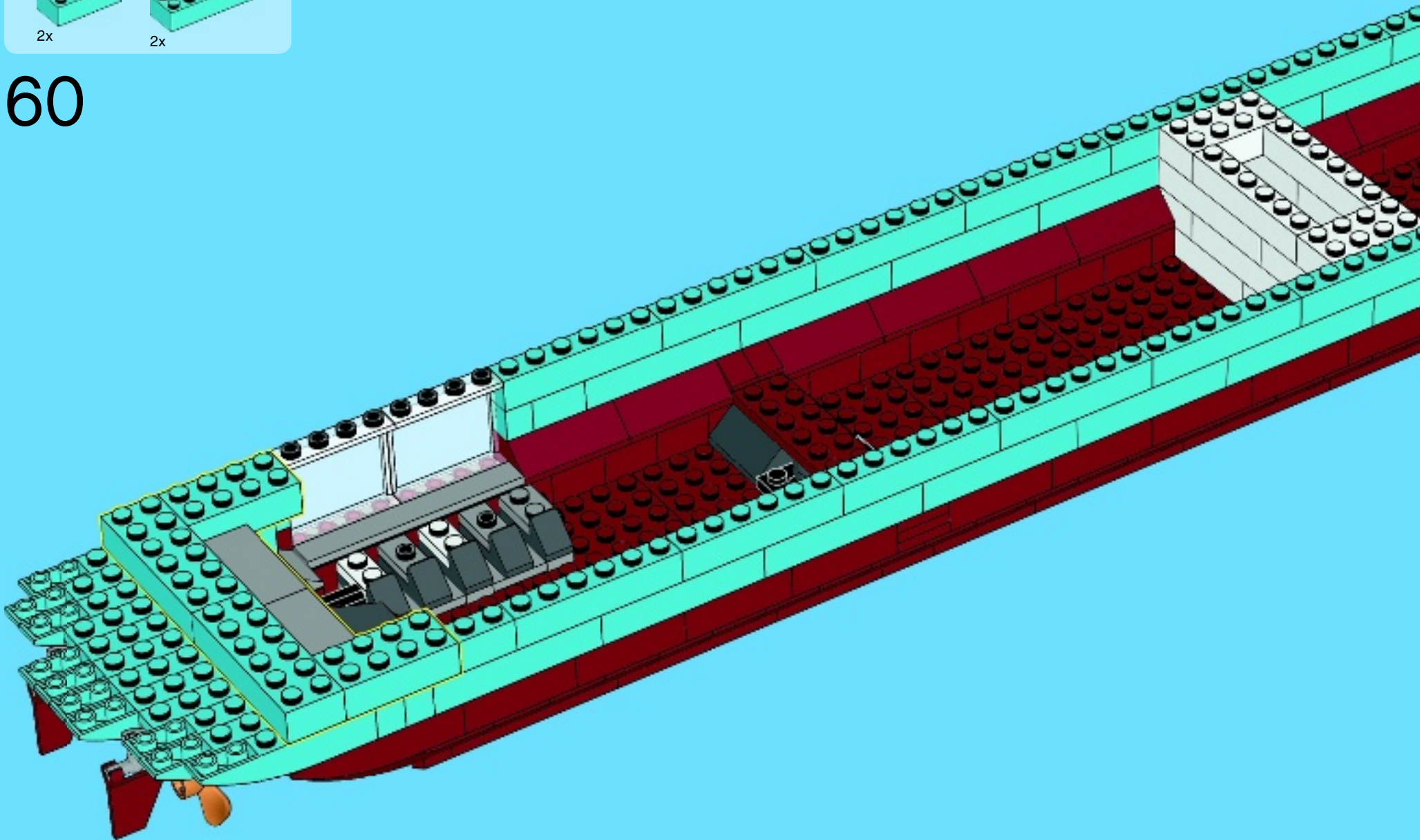

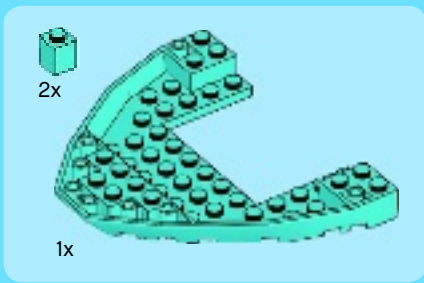

61

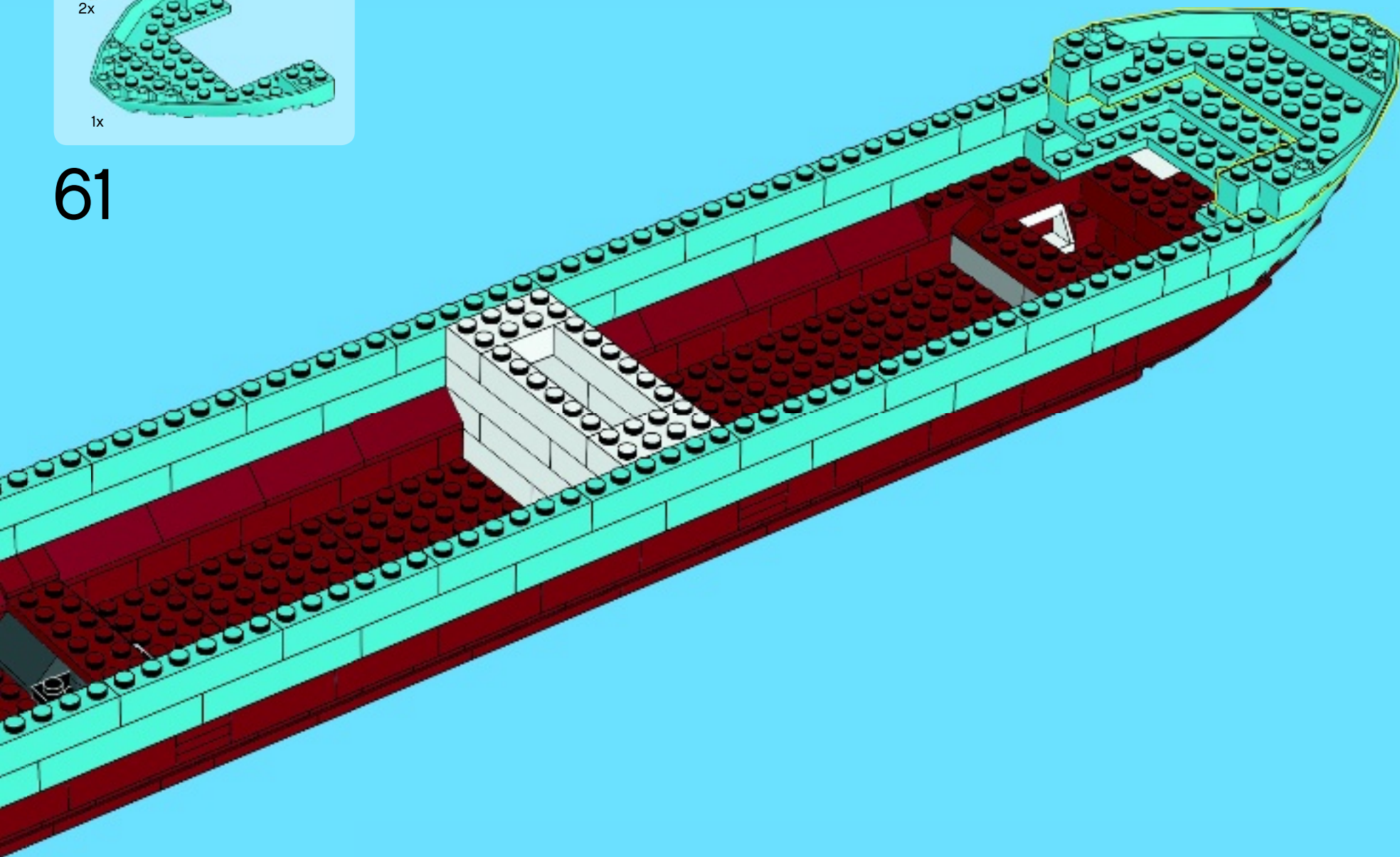

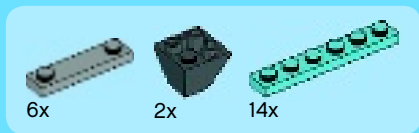

62

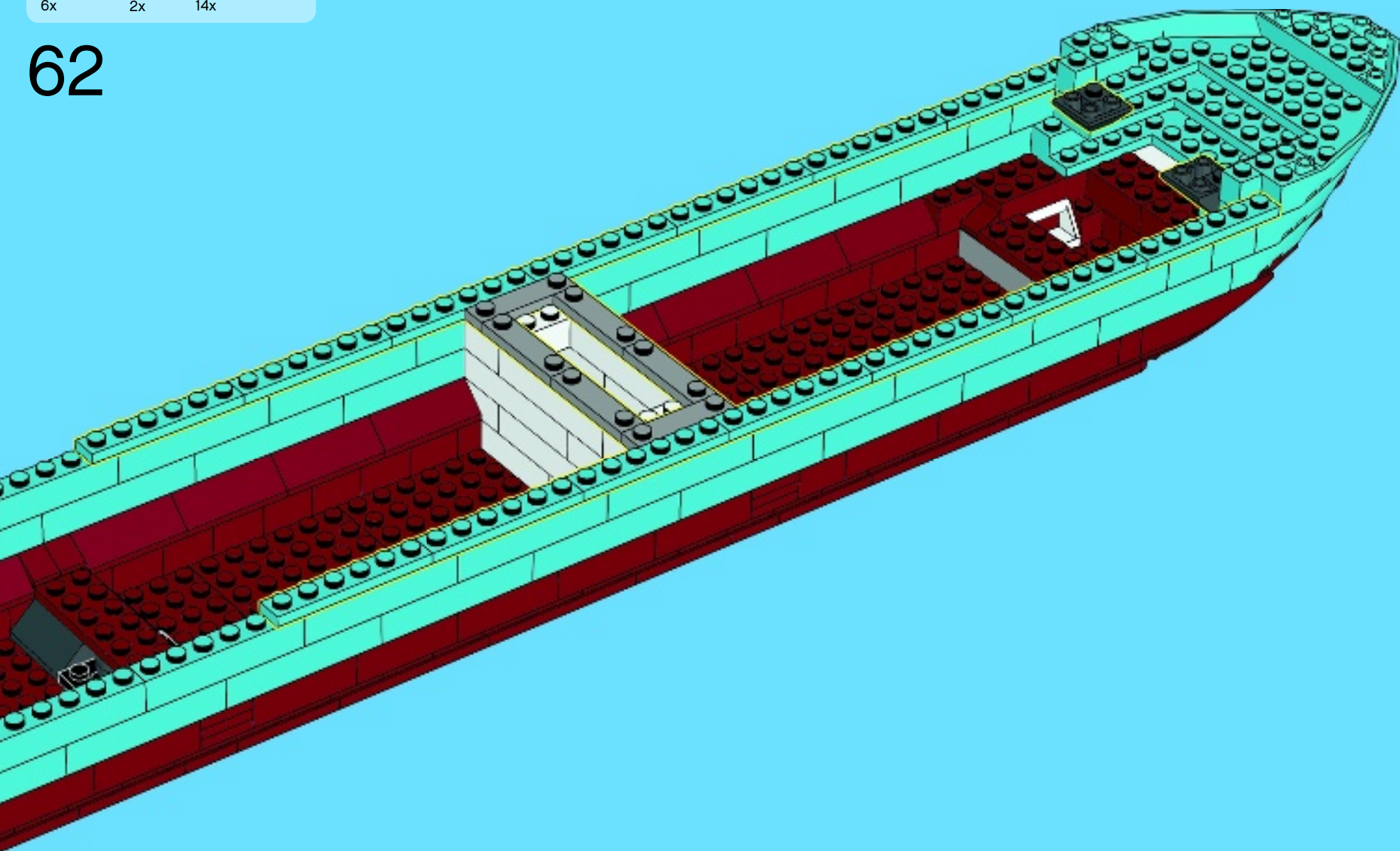

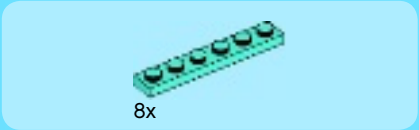

63

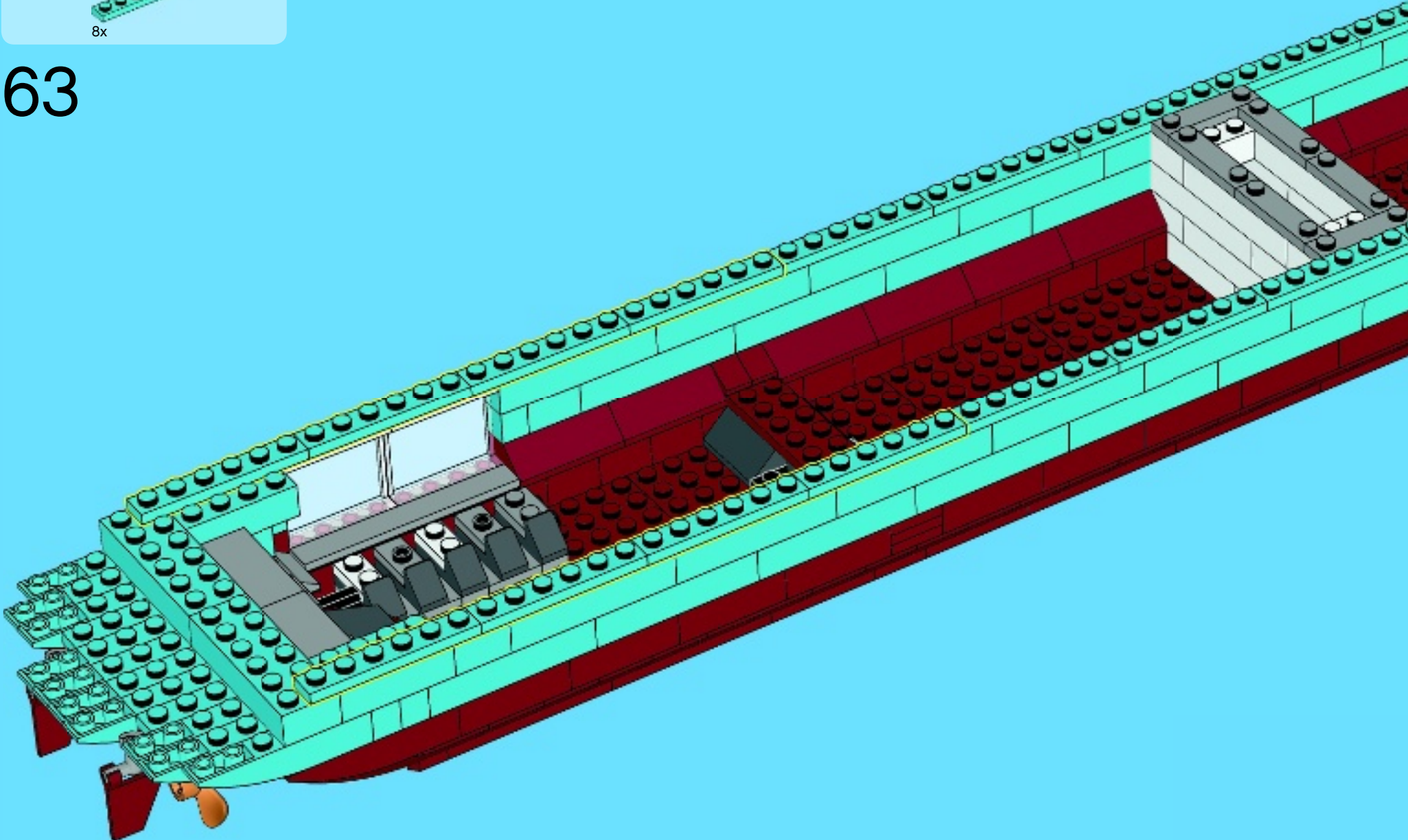



27x

64

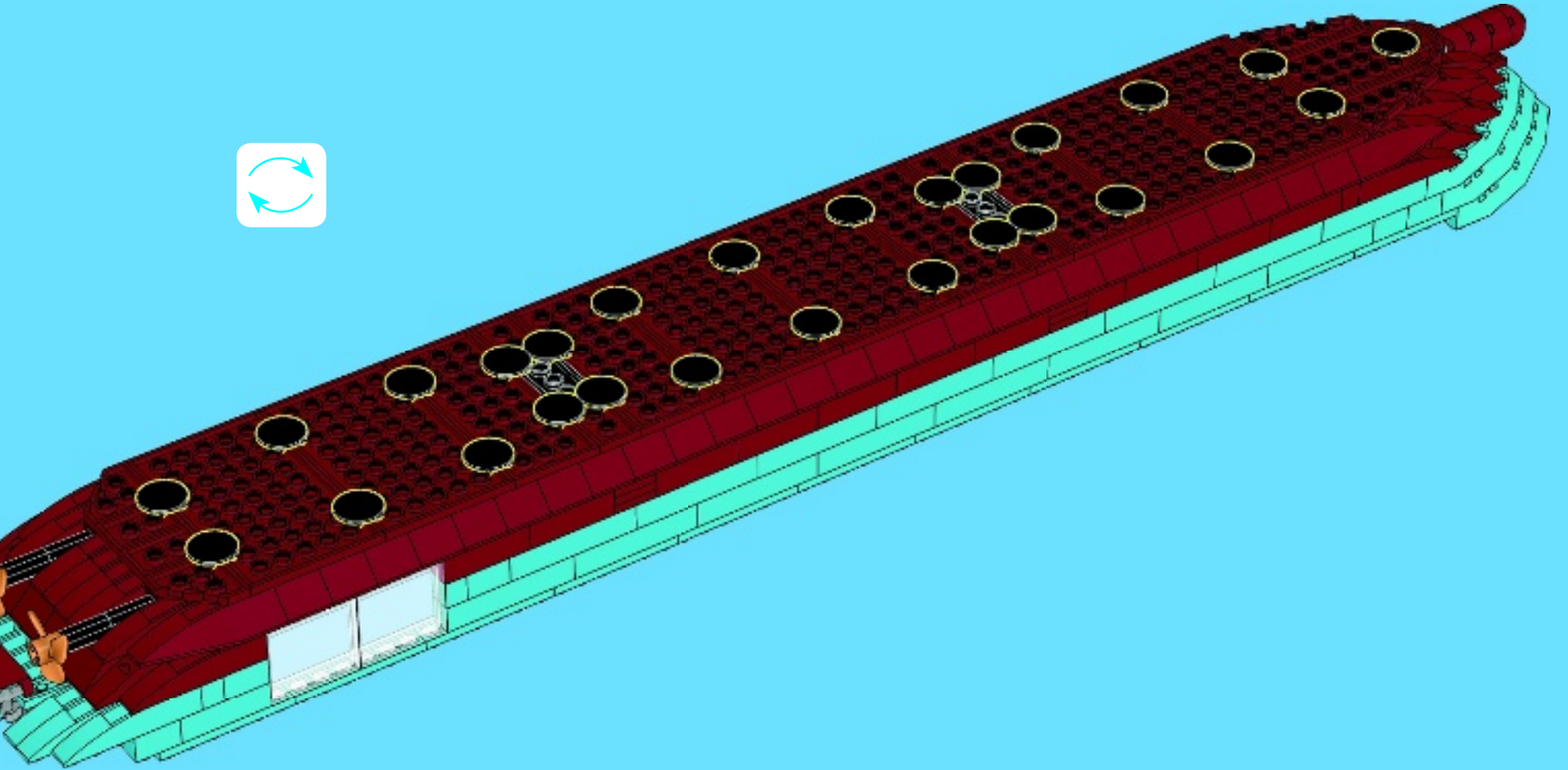

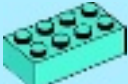
4x  3x 

65

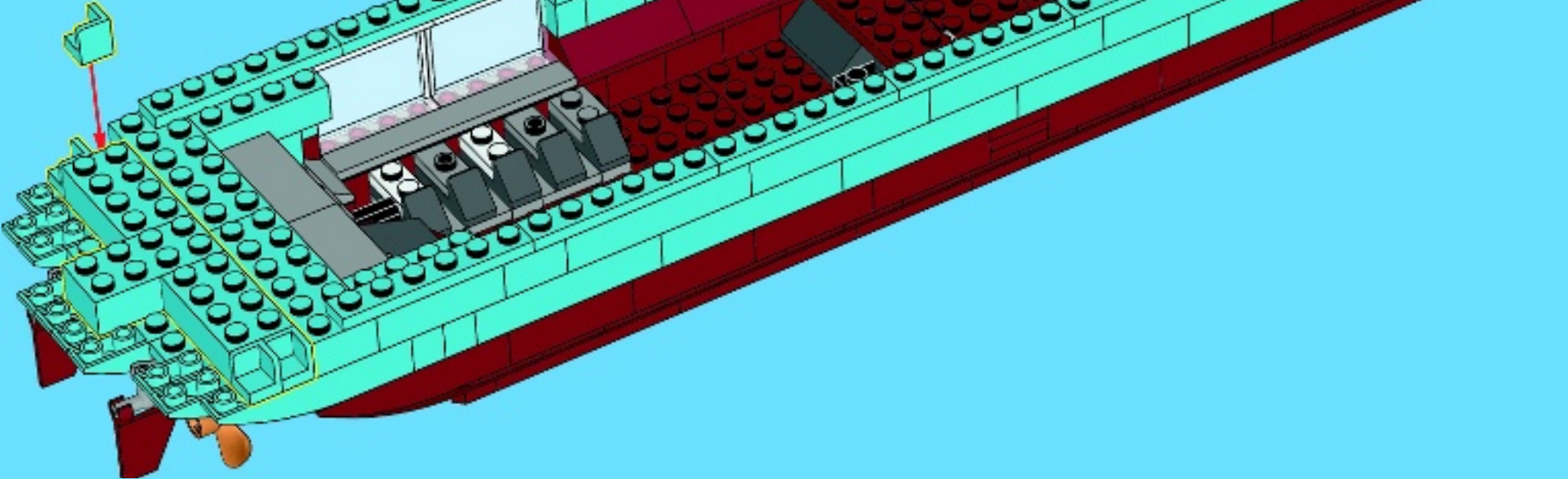

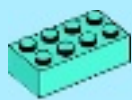

2x



2x



2x

66

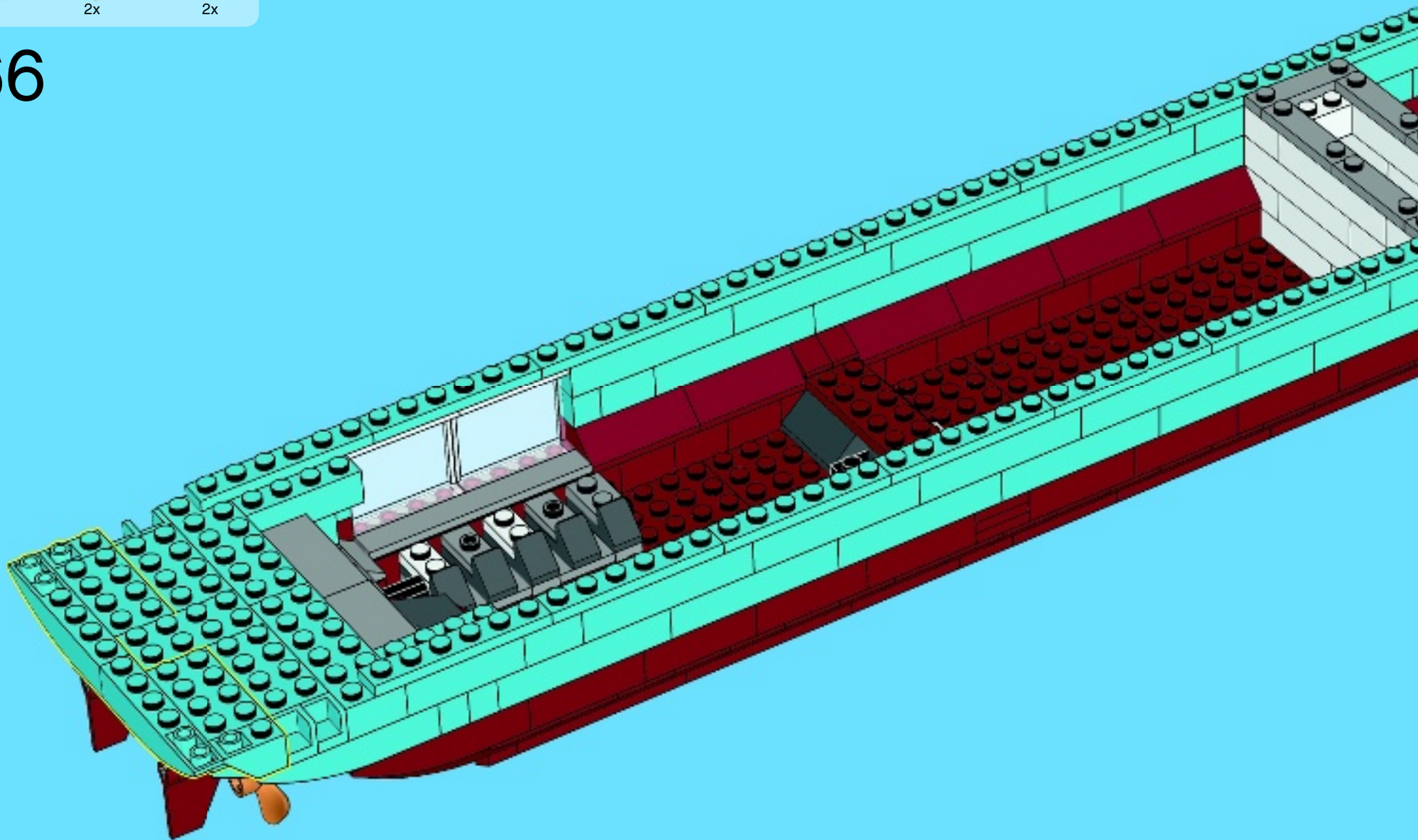

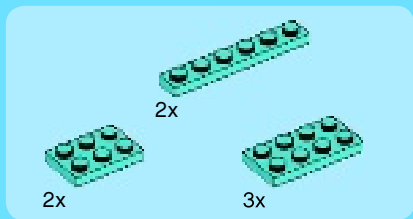

67

NE FORG MO FIRSET HOLLER
RETTEN

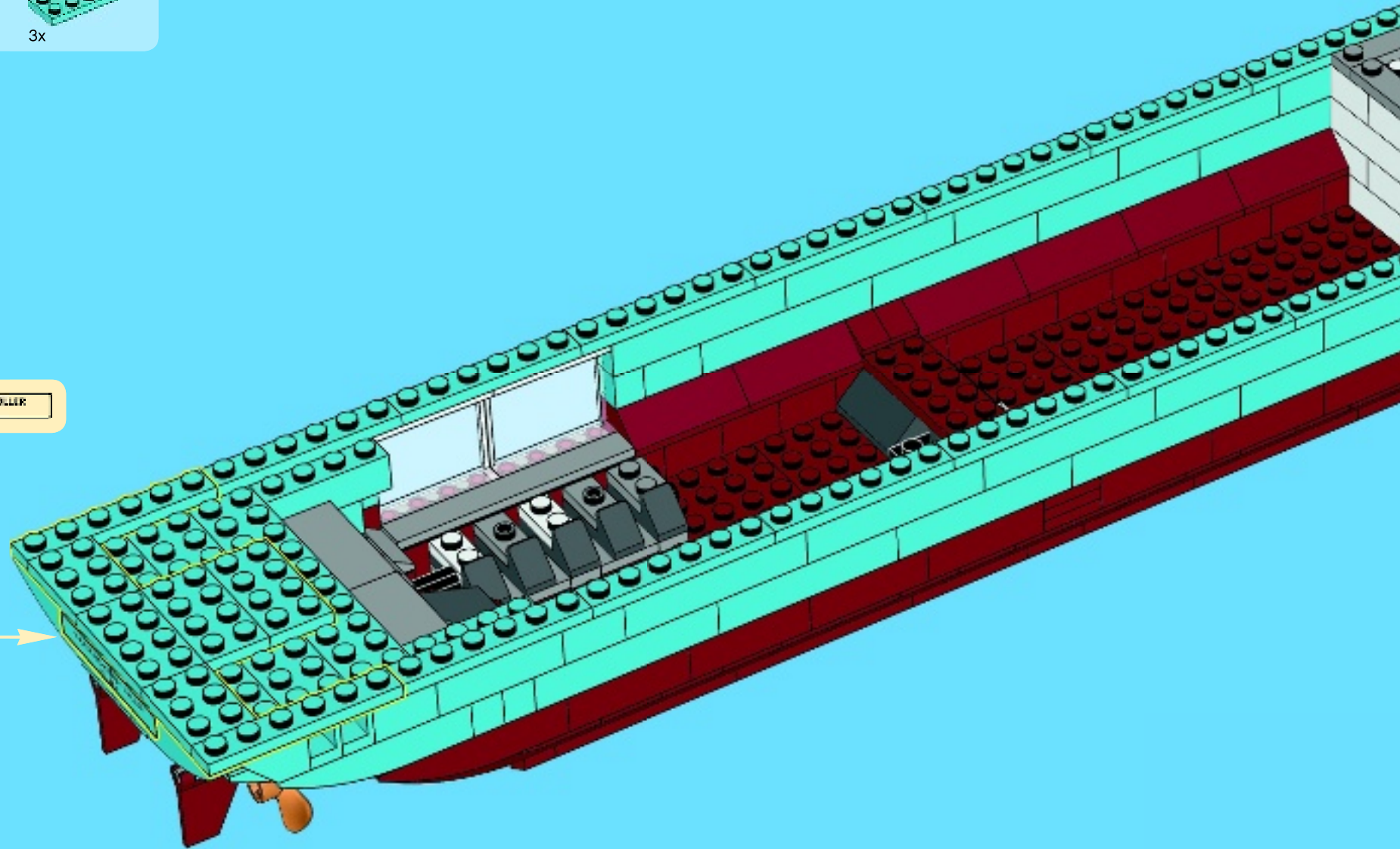

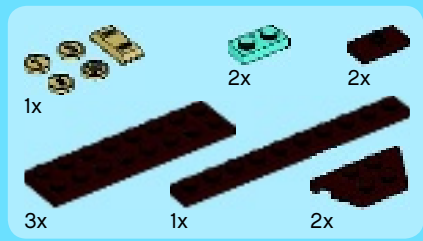

68

MAERSK LINE

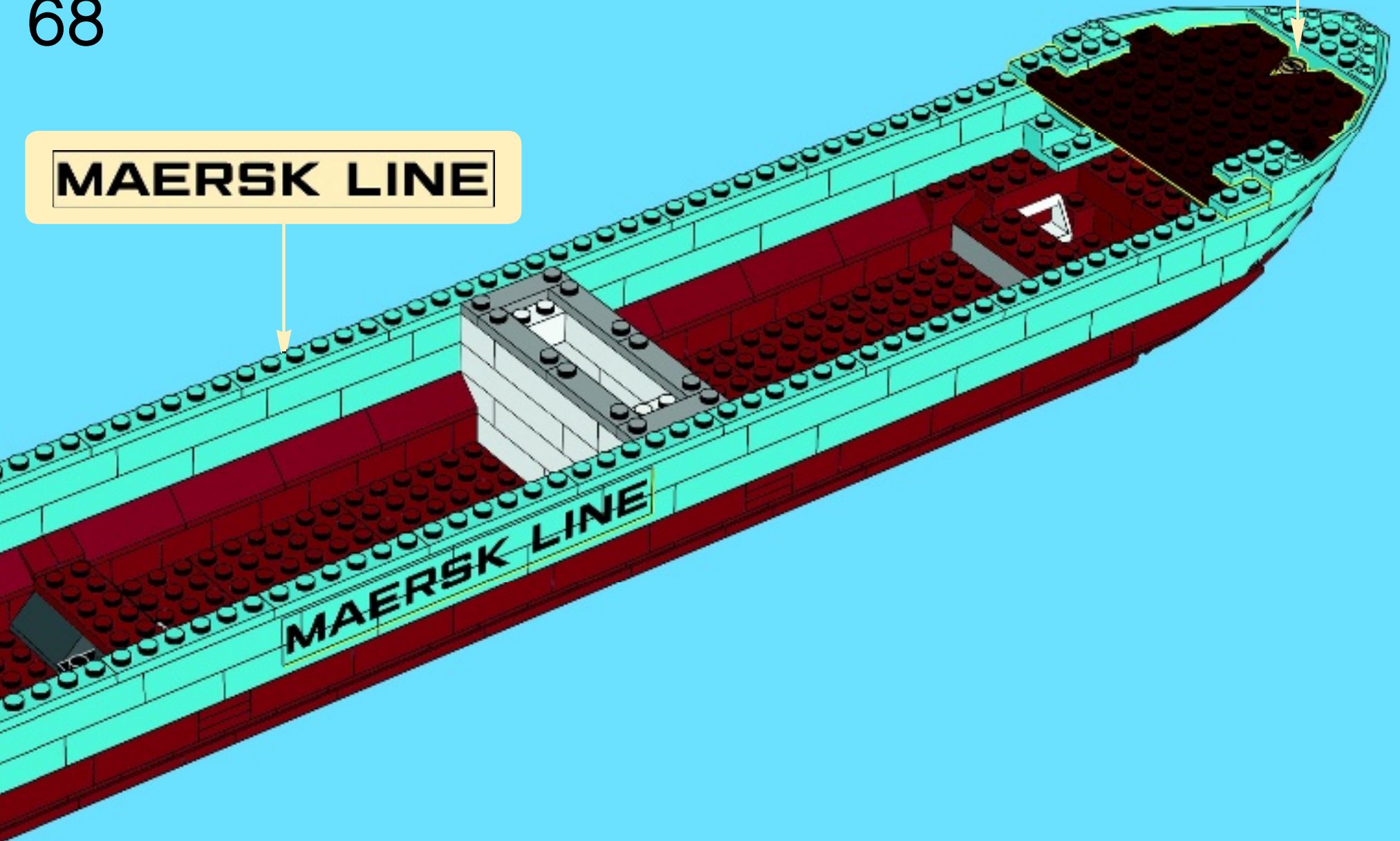

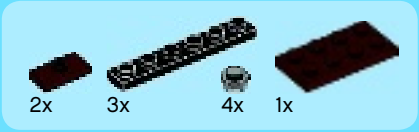

69

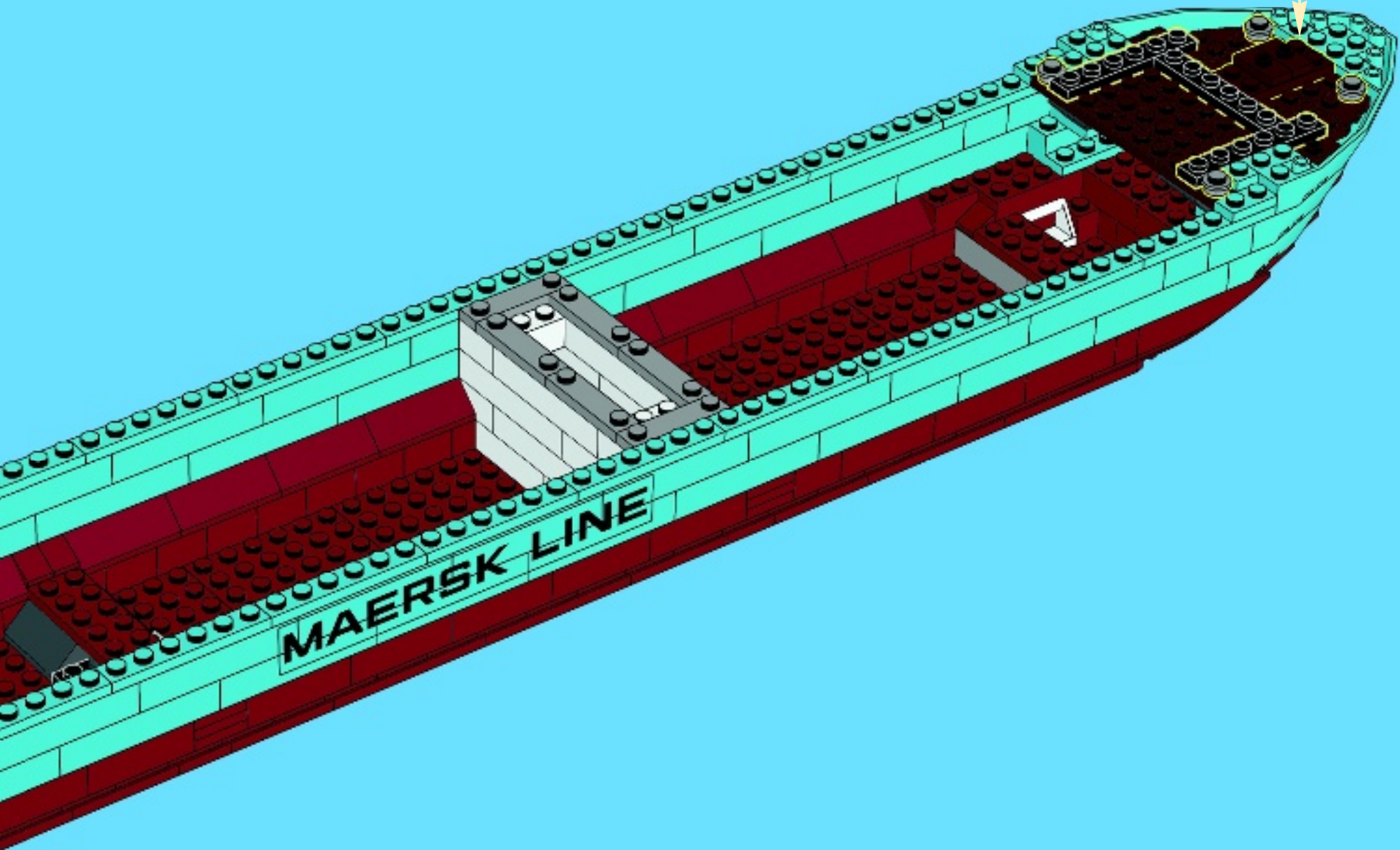
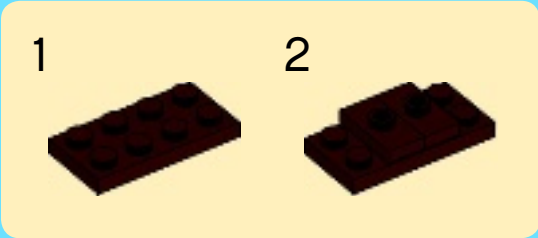

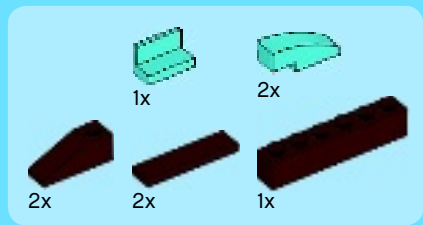

70

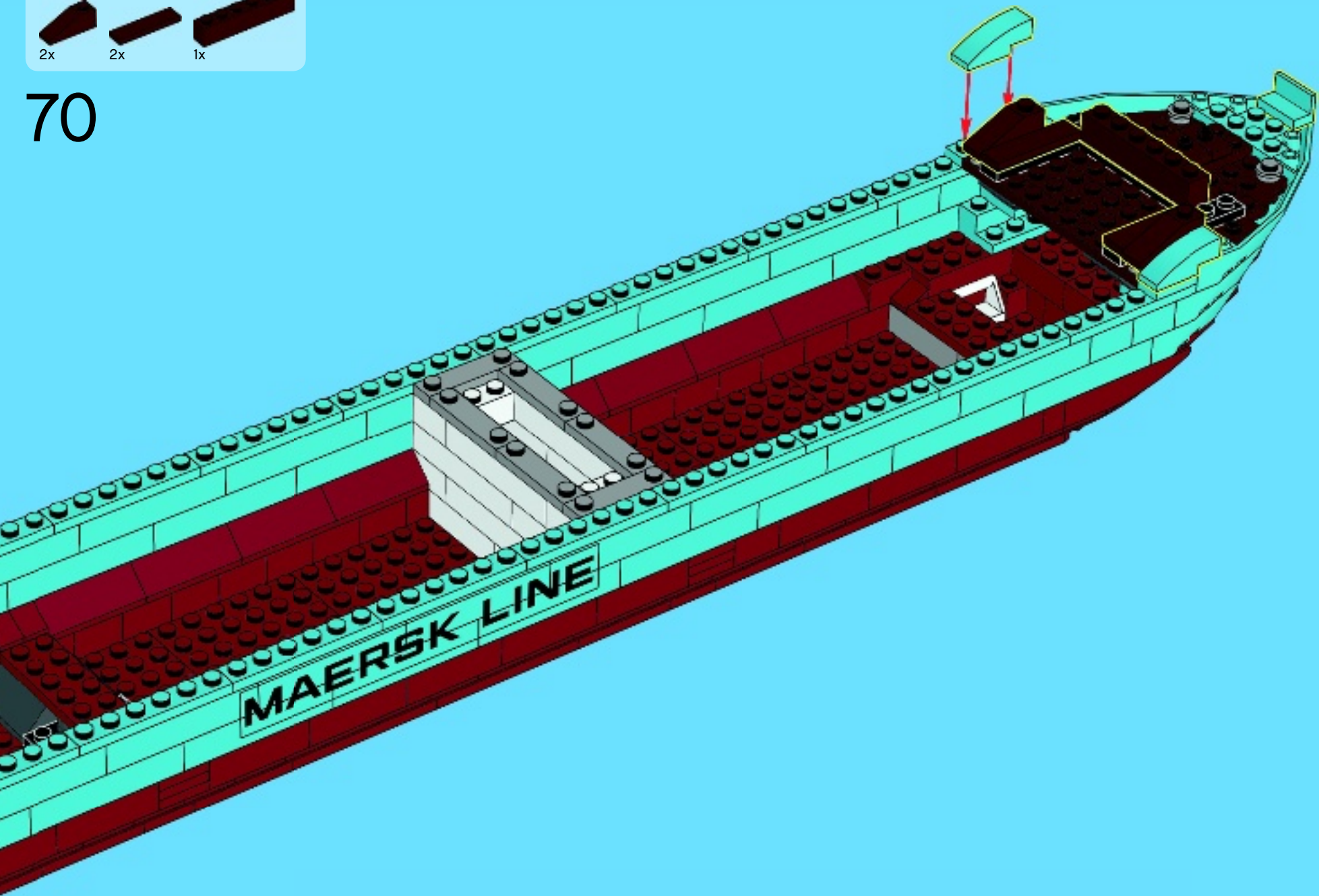

- 6x
- 2x
- 2x
- 2x

71

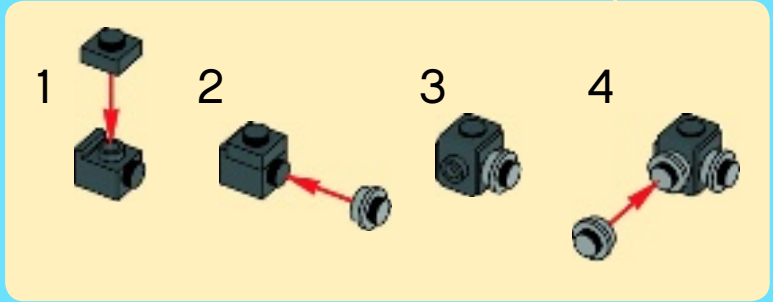
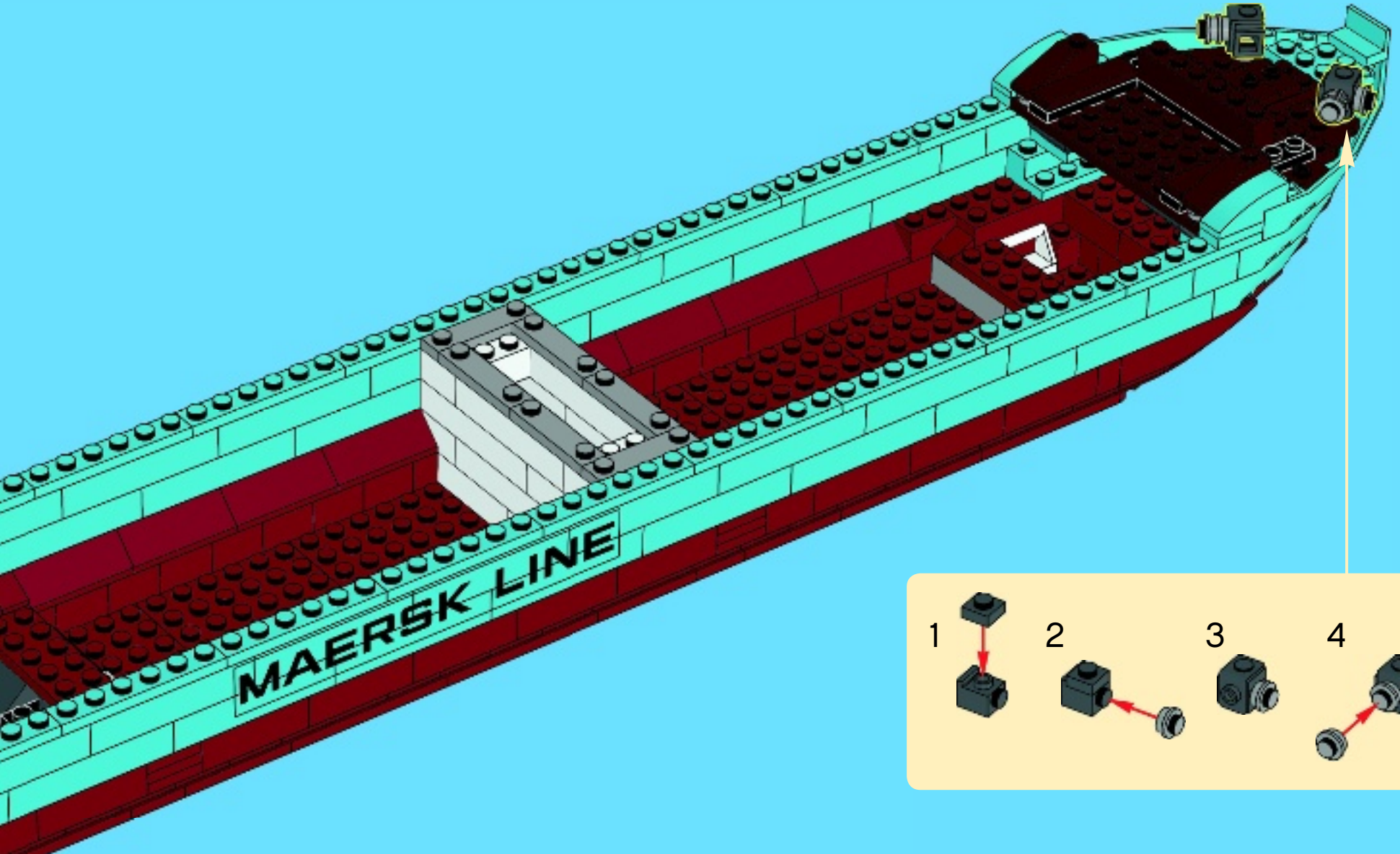
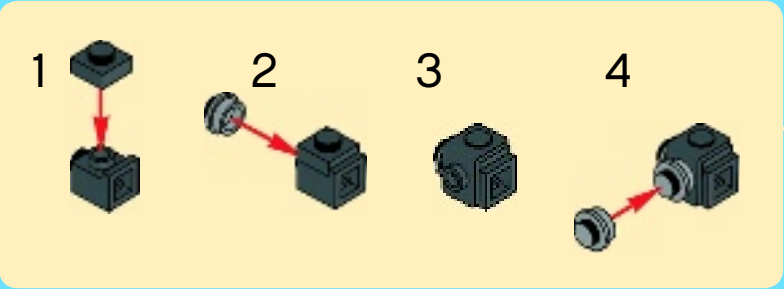

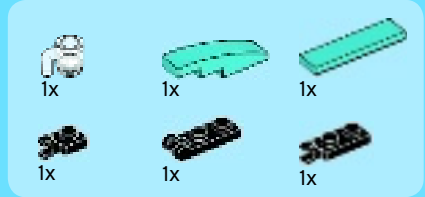

72

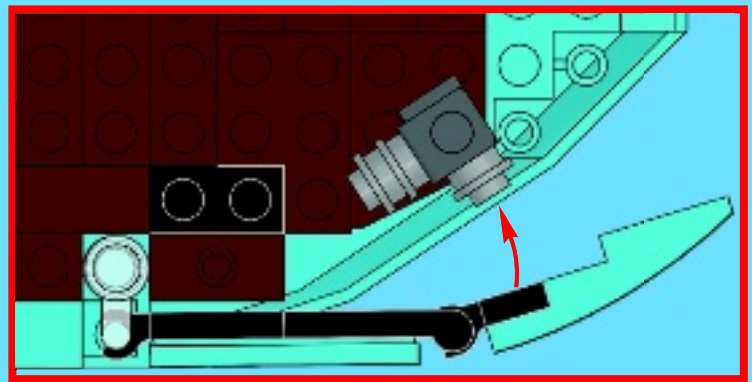
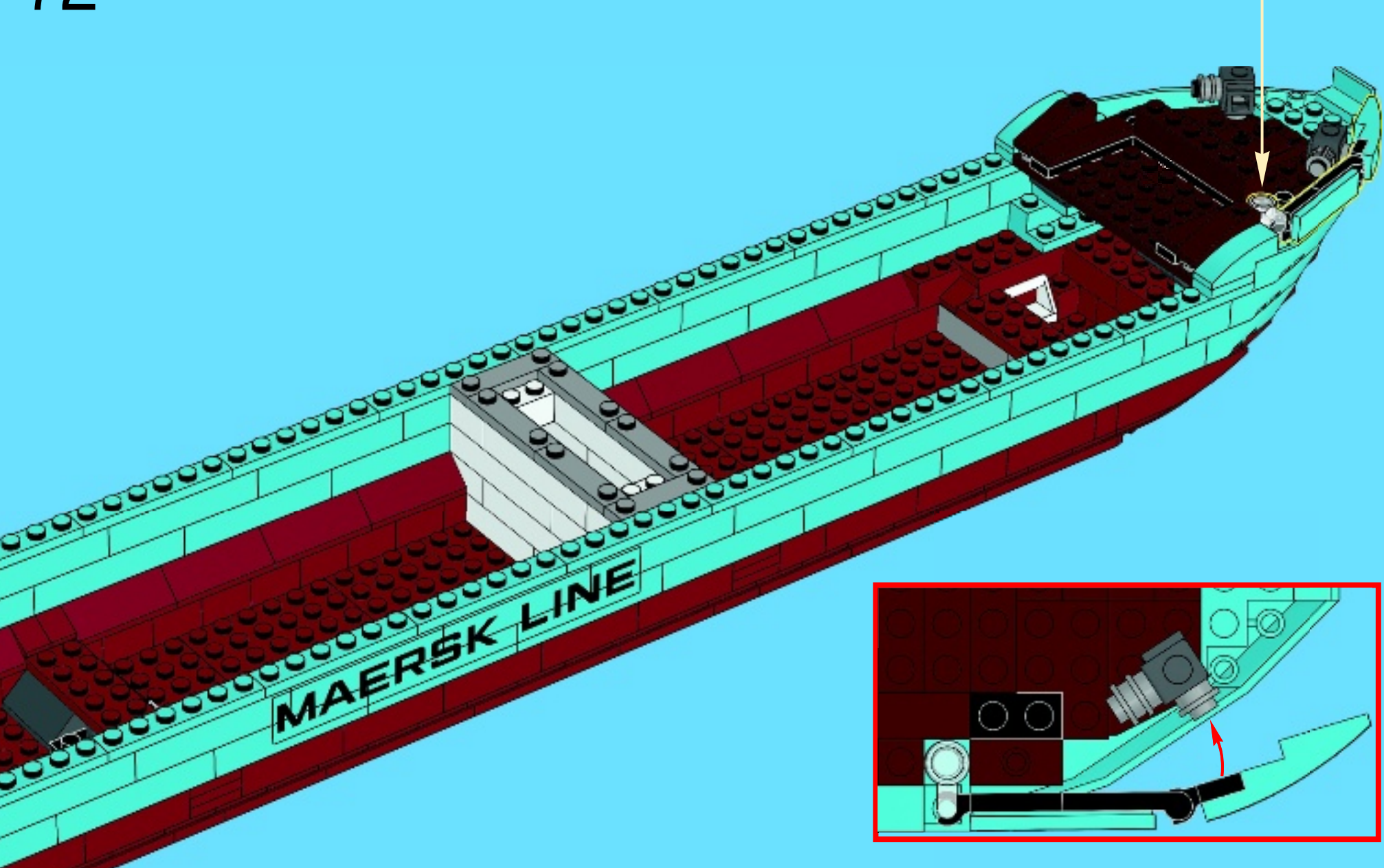
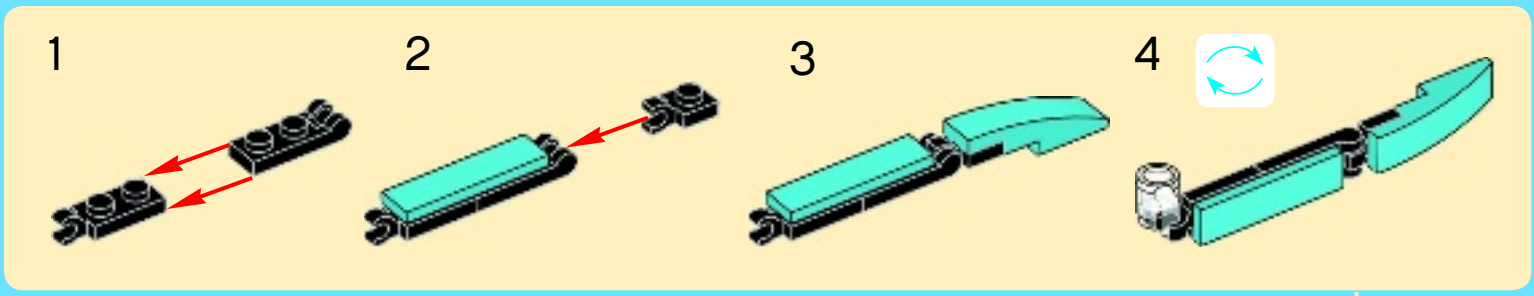

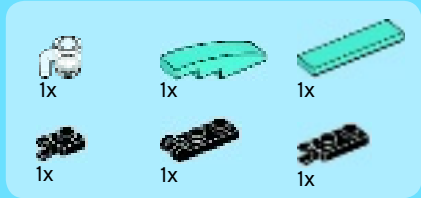

73

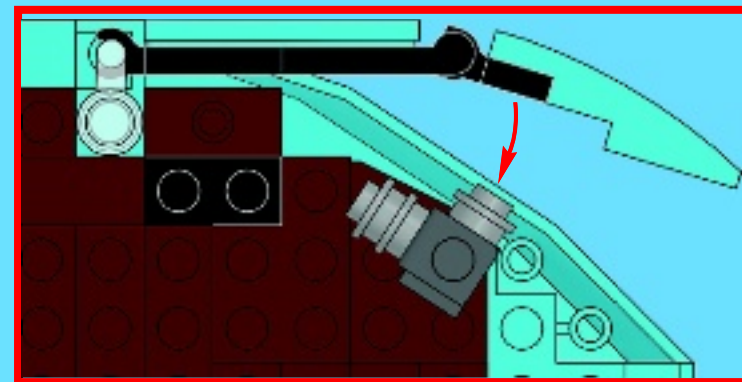
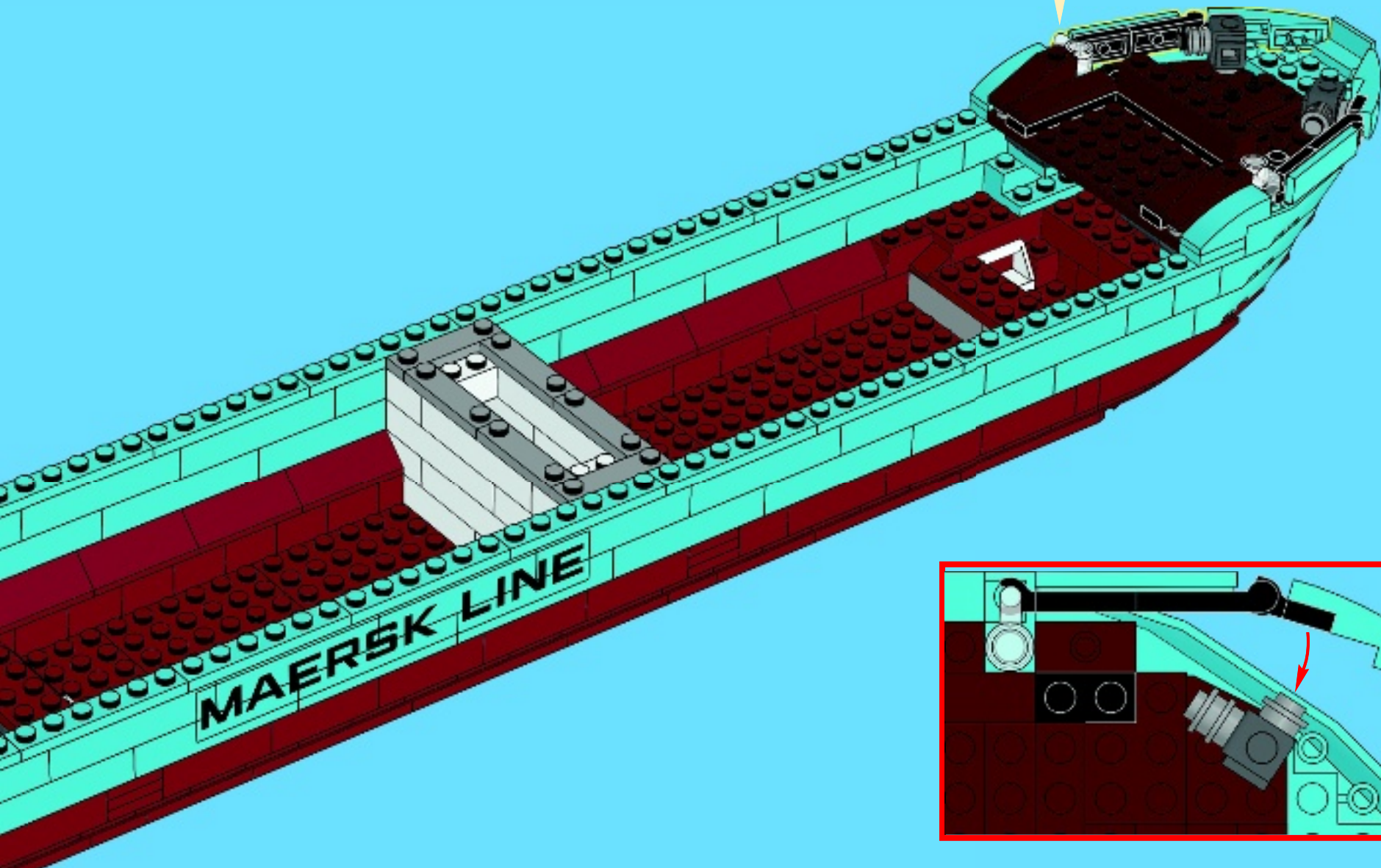
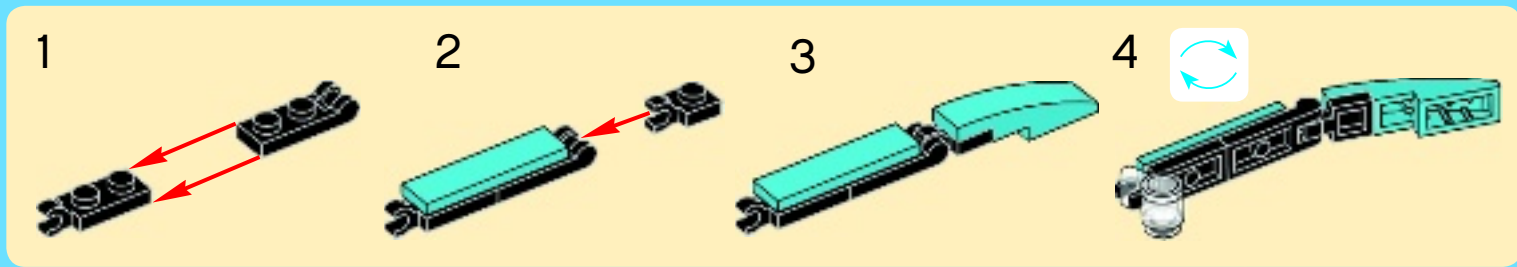



2x



2x



1x

74

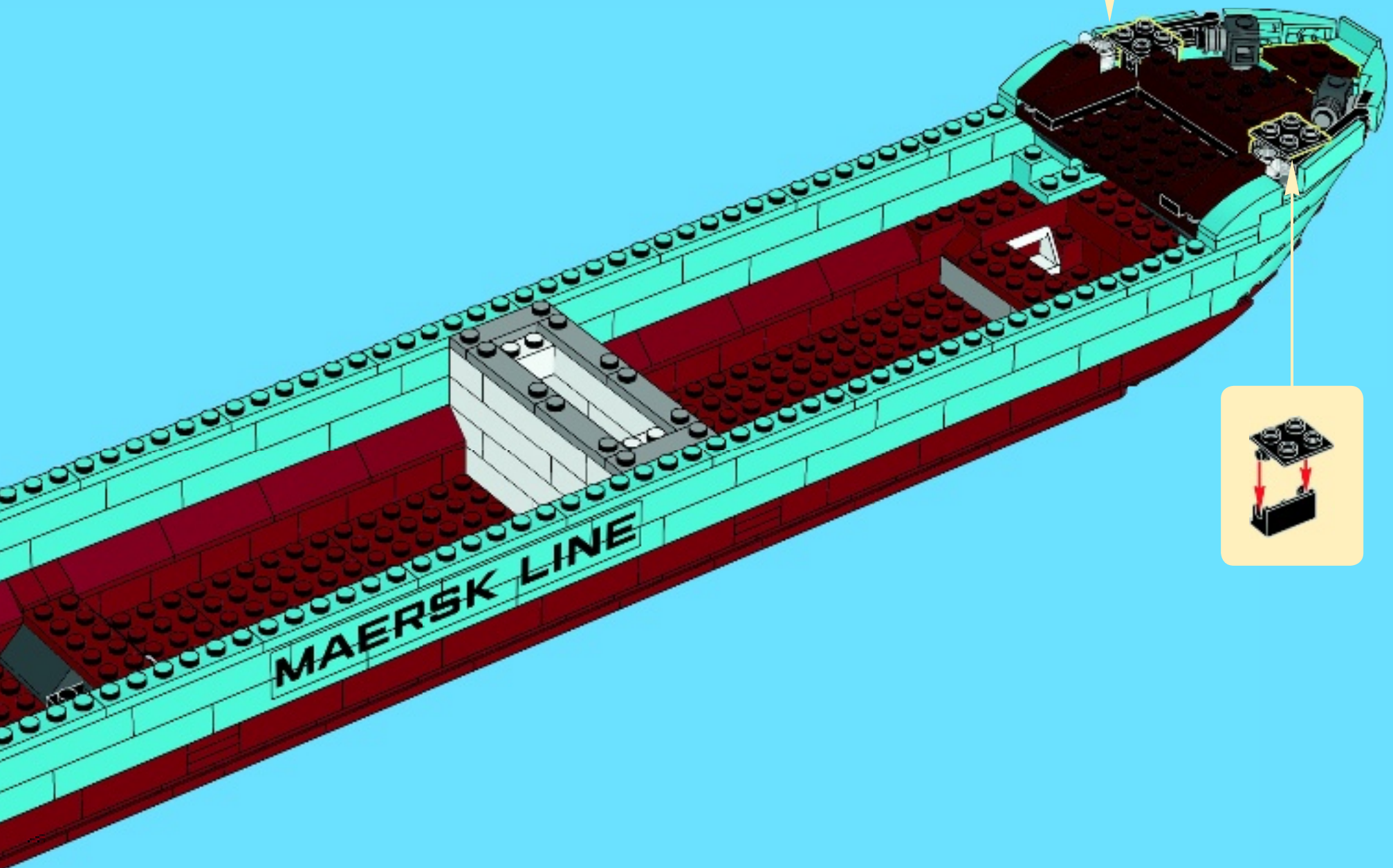
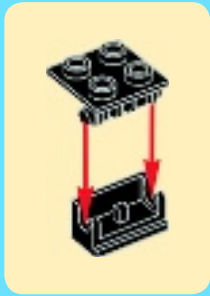

MAERSK LINE

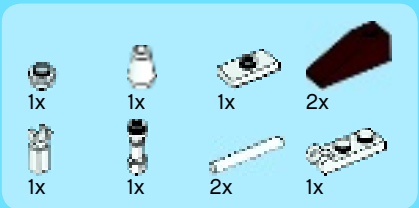

75

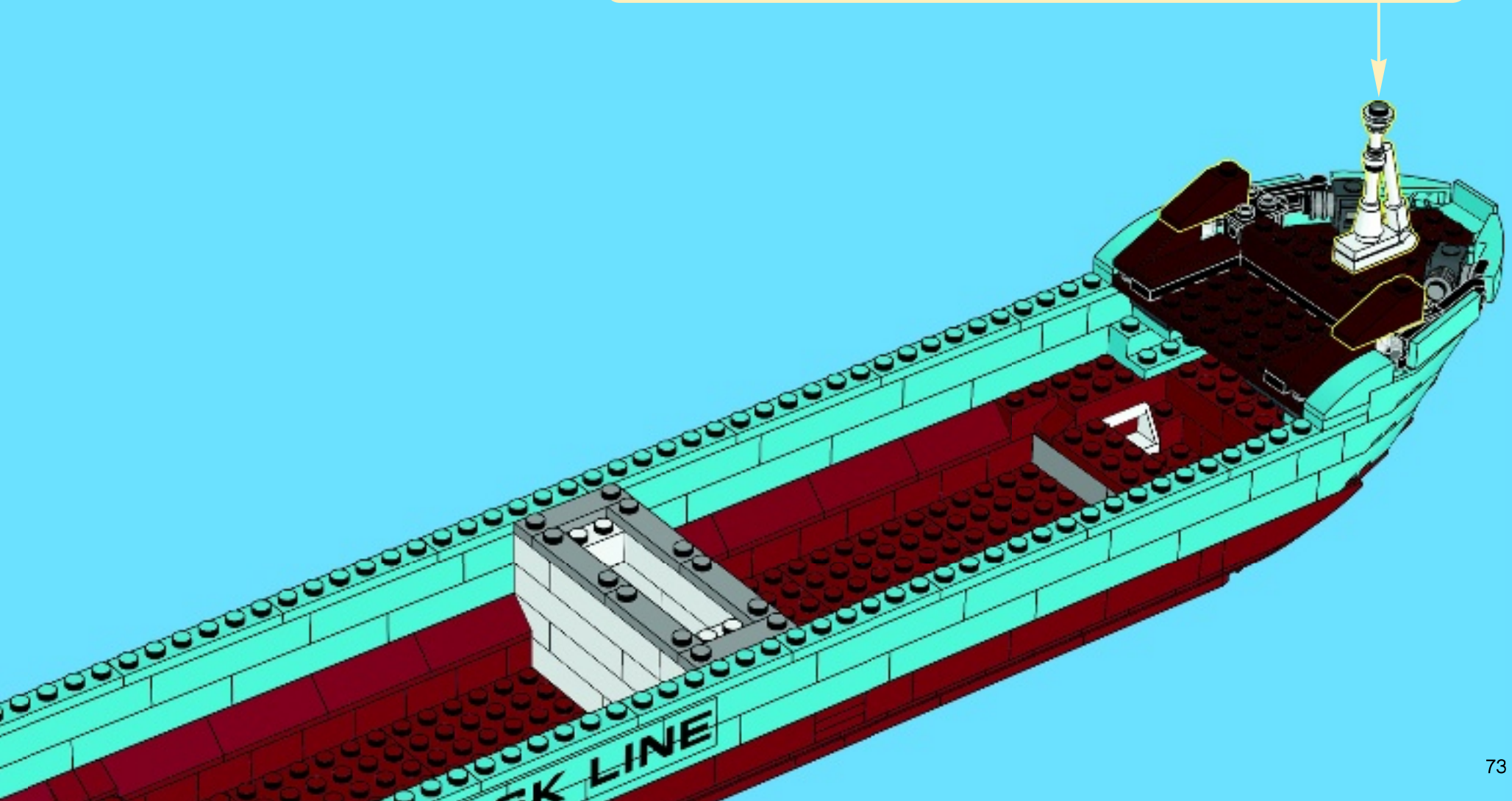
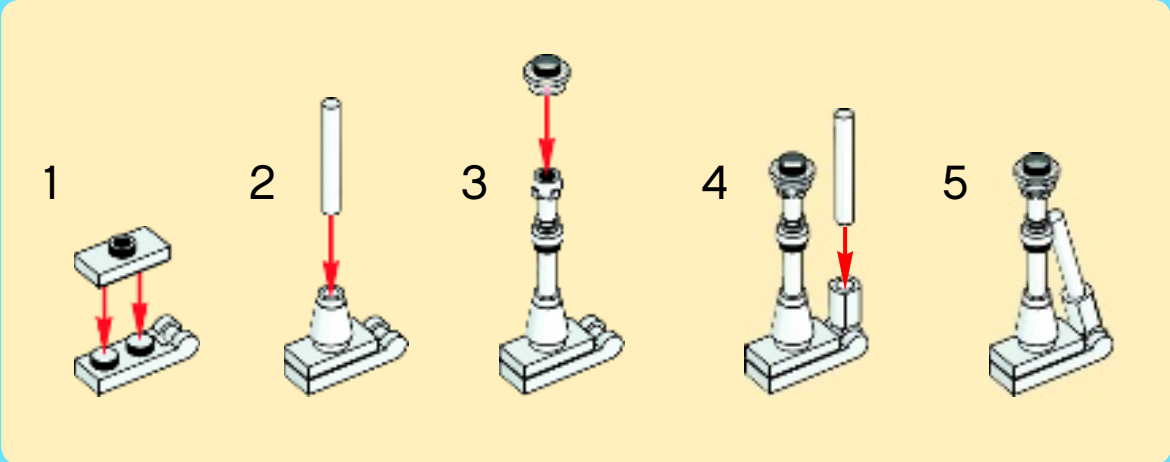

1x

1x

2x

76

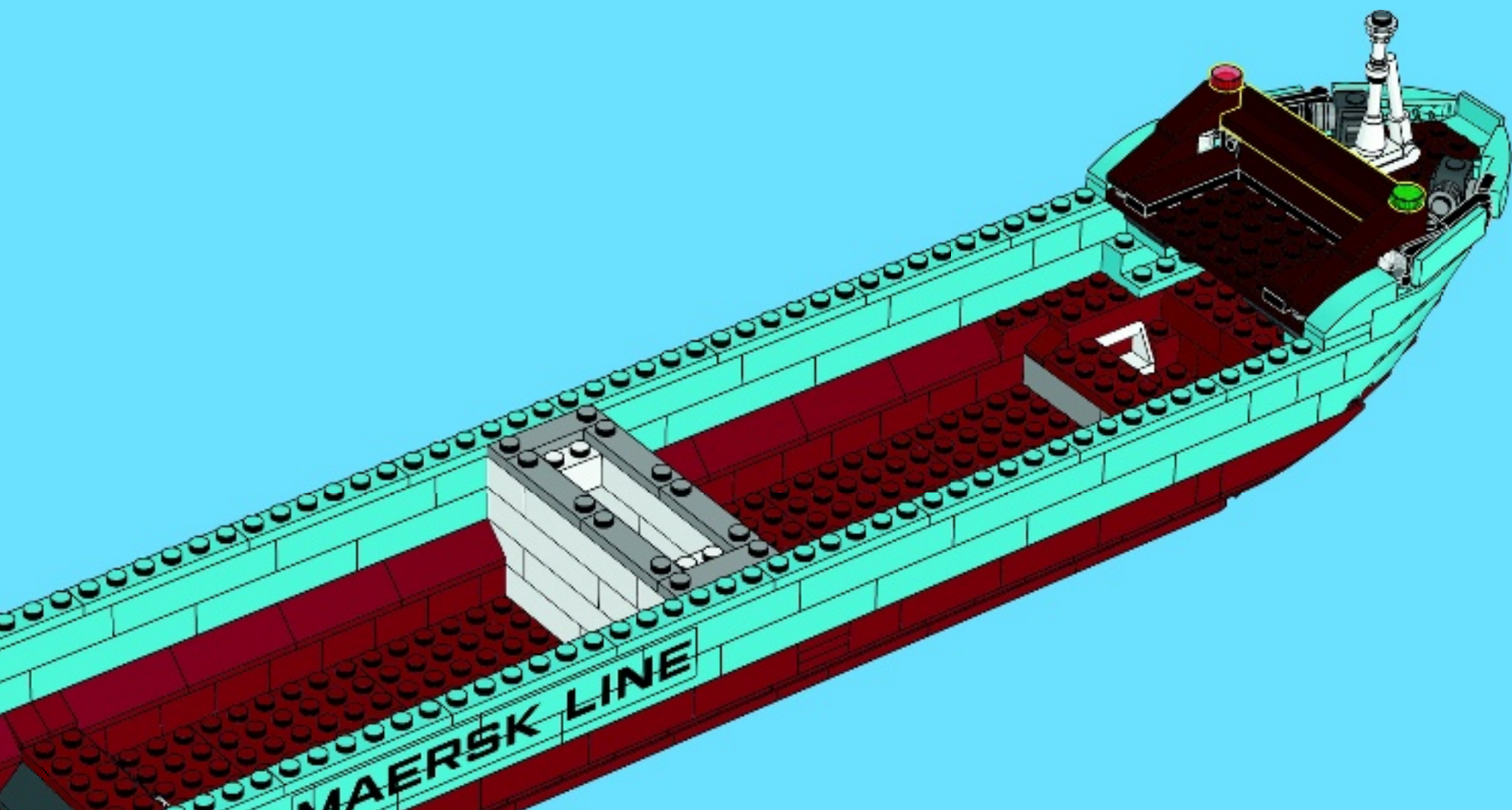

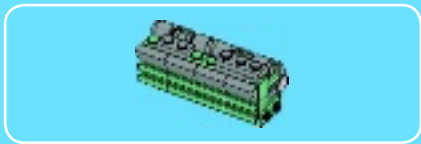

1

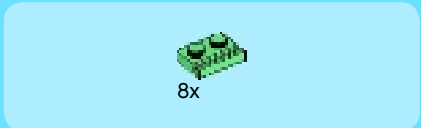
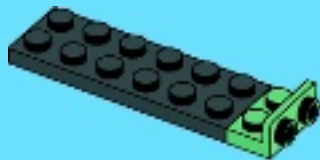

2

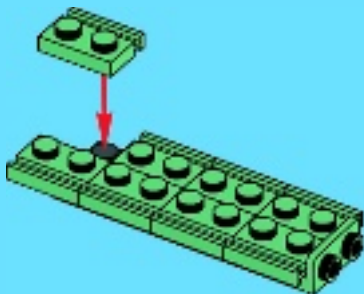

3

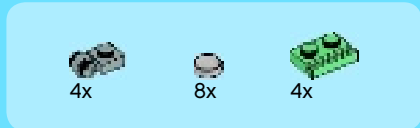
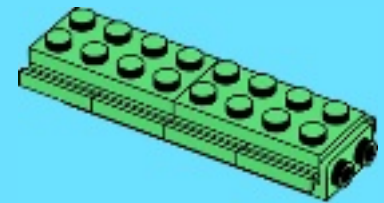

4

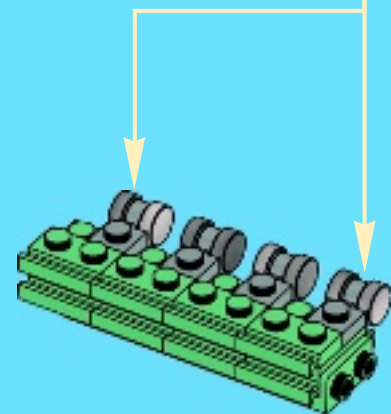
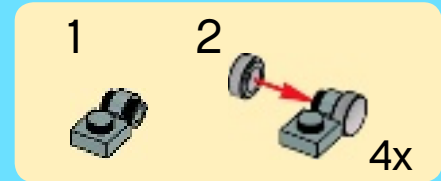

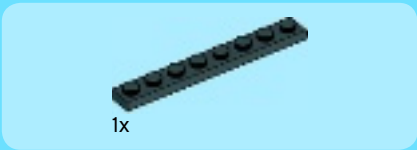

5

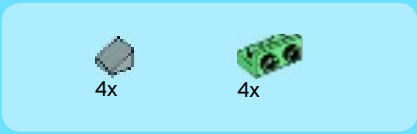
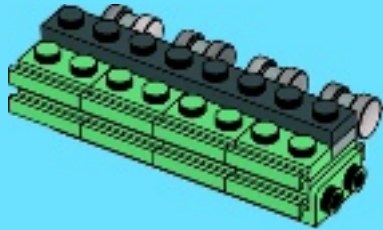

6

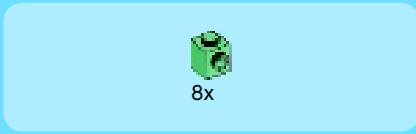
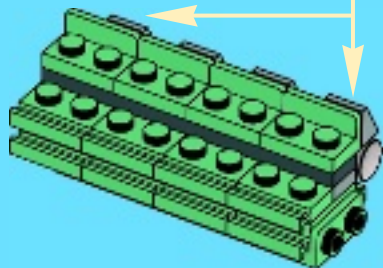
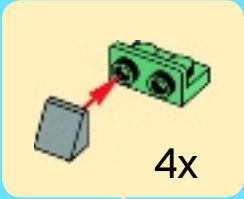

7

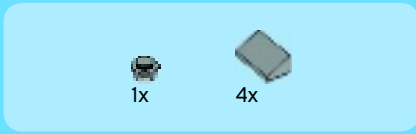
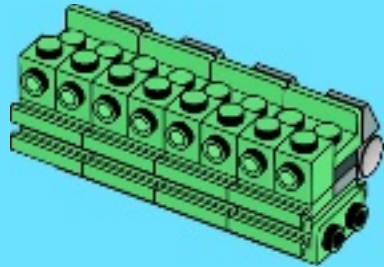

8

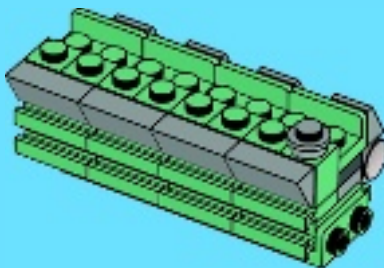



4x



2x

9

1



2

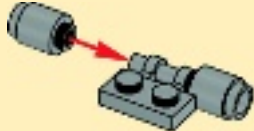

2x

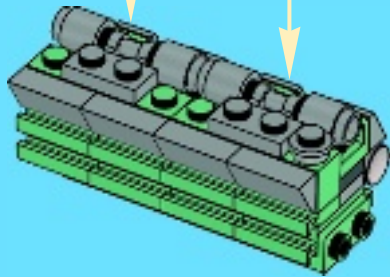

1x

10

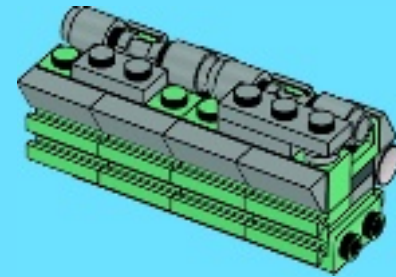

77

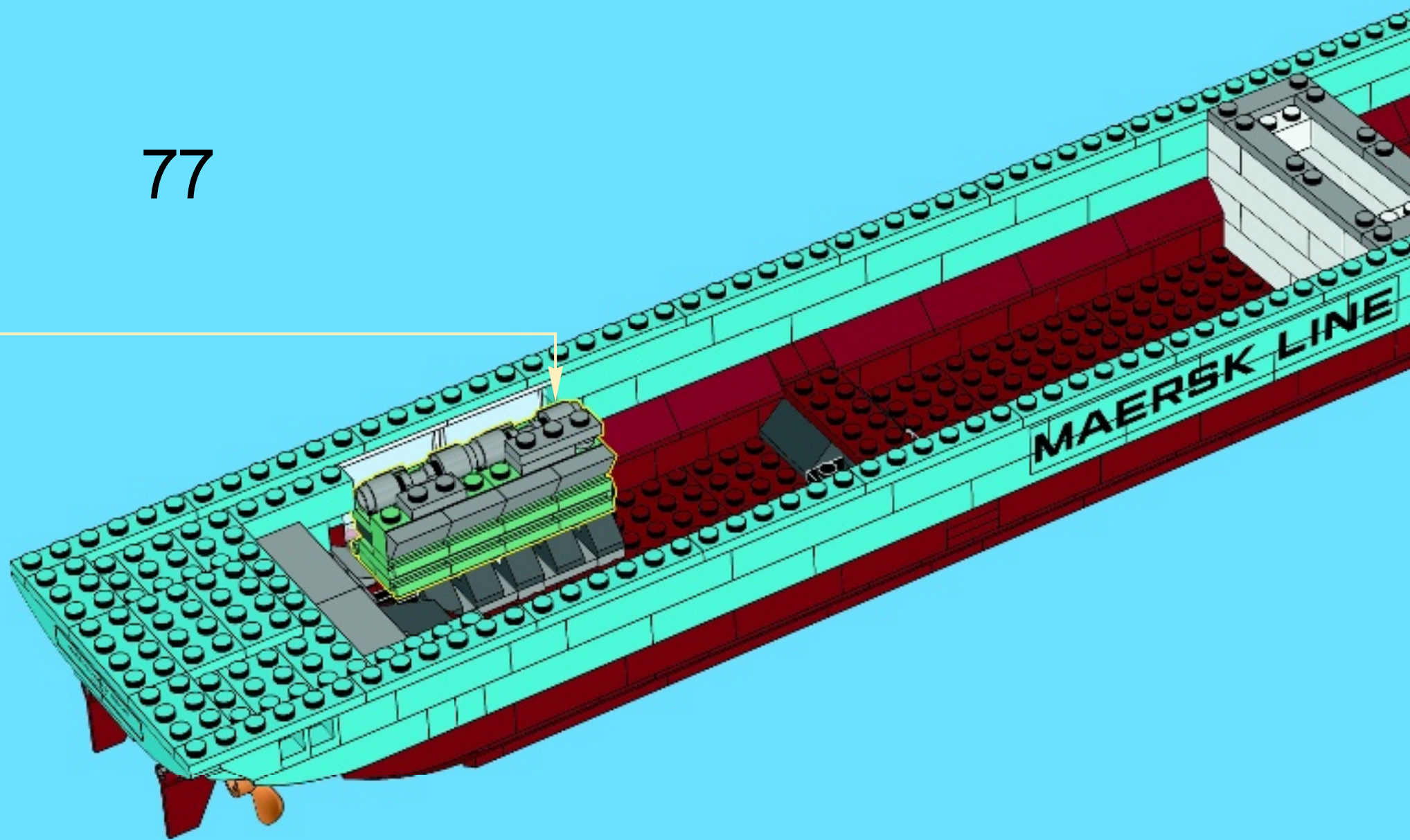

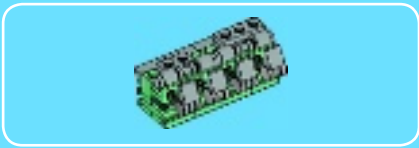

1



2

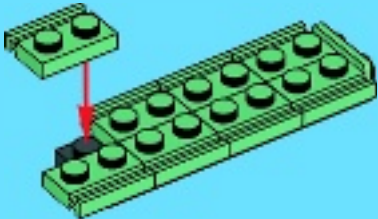

3

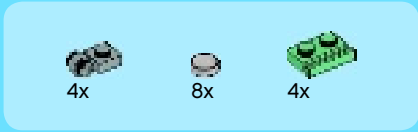
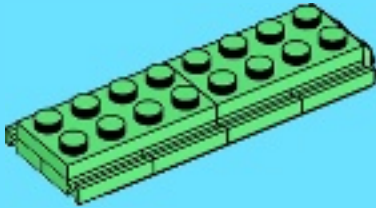

4

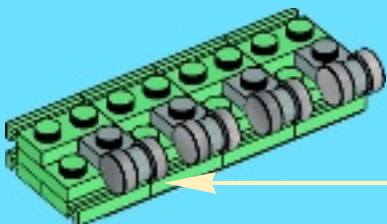

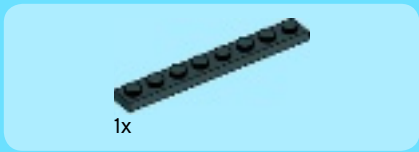

5

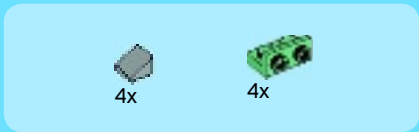
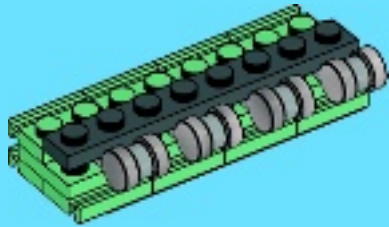

6

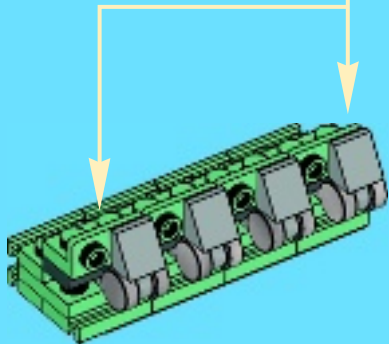
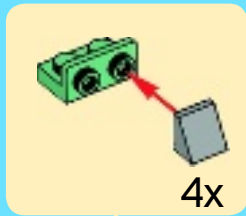

7

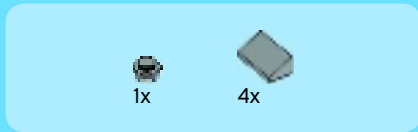
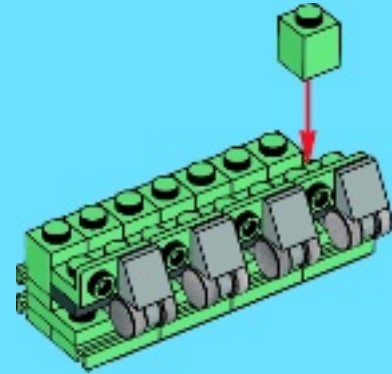

8

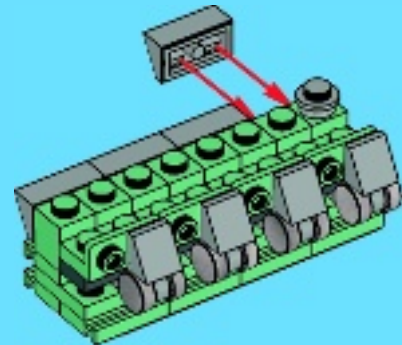



4x



2x

9

1



2

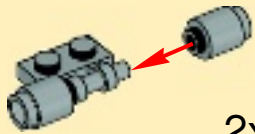

2x

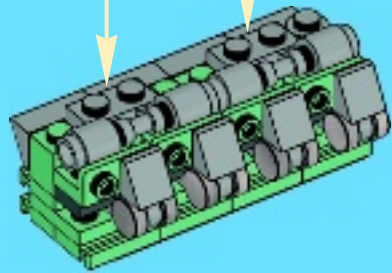

1x

10

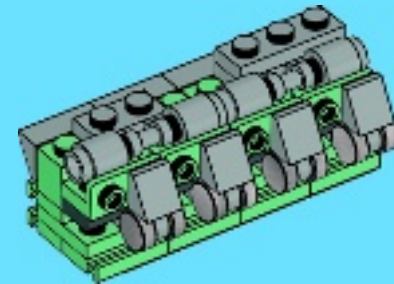

78

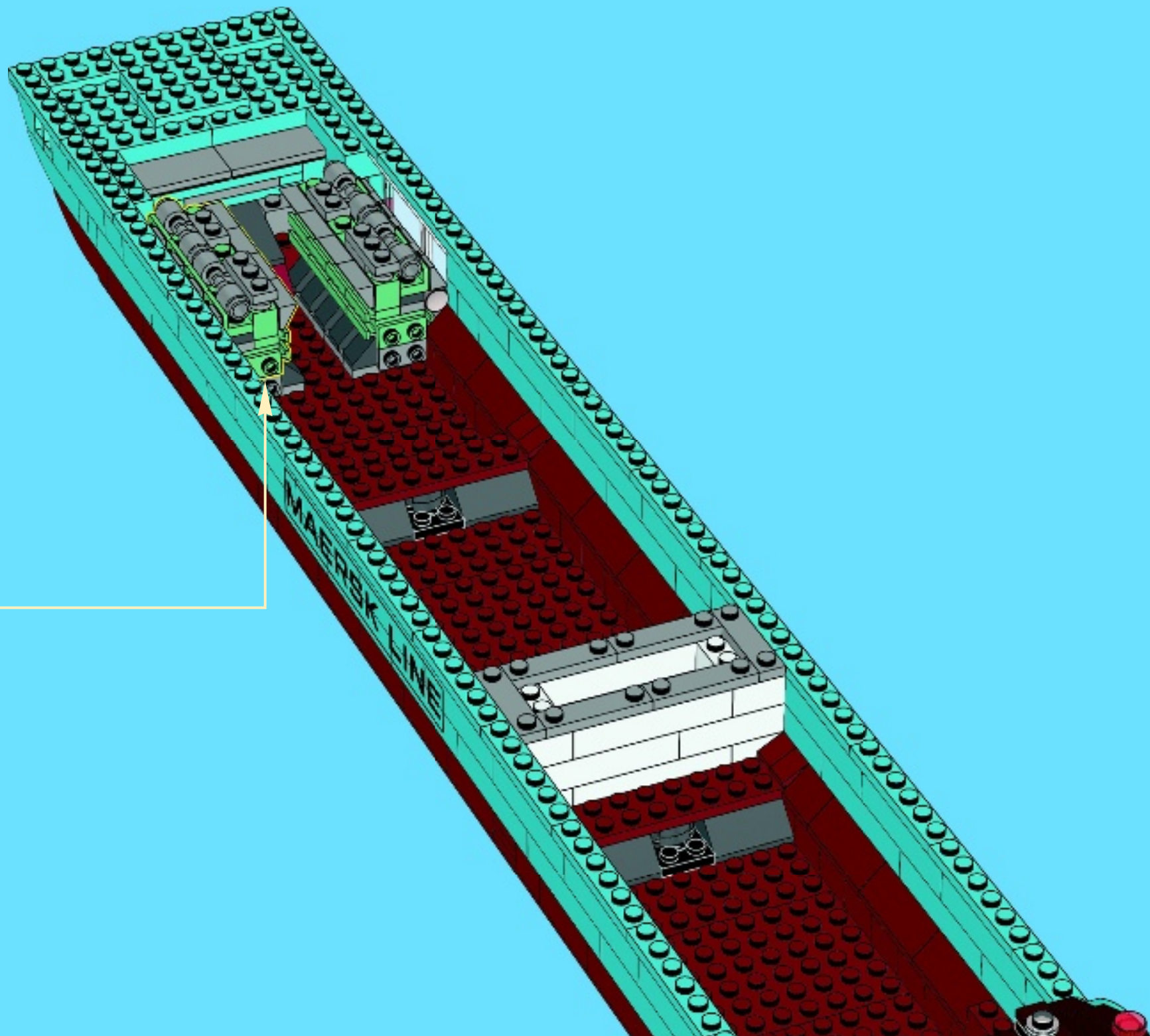



2x

79

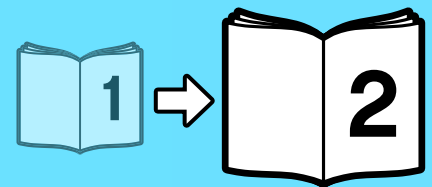
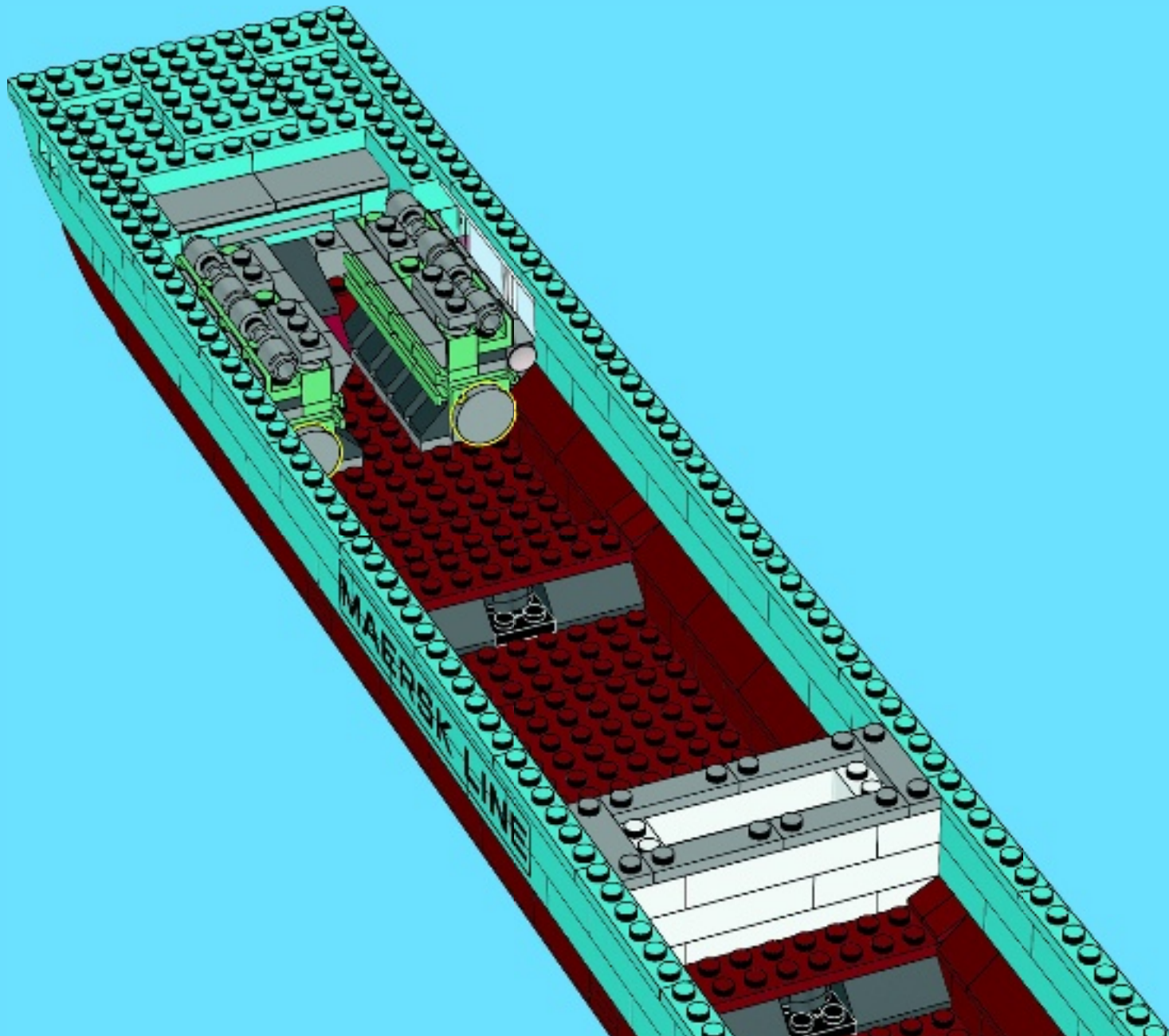



club™

Free*! Gratuit!

* Paid subscription in Australia and New Zealand.
Abonnement payant en Australie et Nouvelle-Zélande.

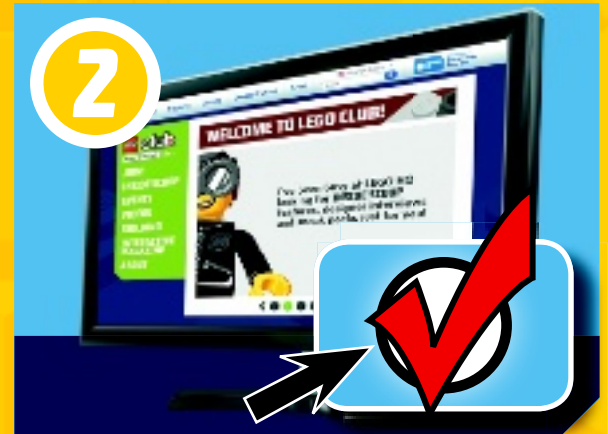

LEGO.com/club



LEGO and the LEGO logo are trademarks of the/son des marques de commerce de/son marcas registradas de LEGO Group. ©2014 The LEGO Group. 6104037 / 6104041